

ENGINEERING
YOUR SPRAY SOLUTION



➤ SPRAY HEADERS

~~How to get sprays in line~~

METALLURGY



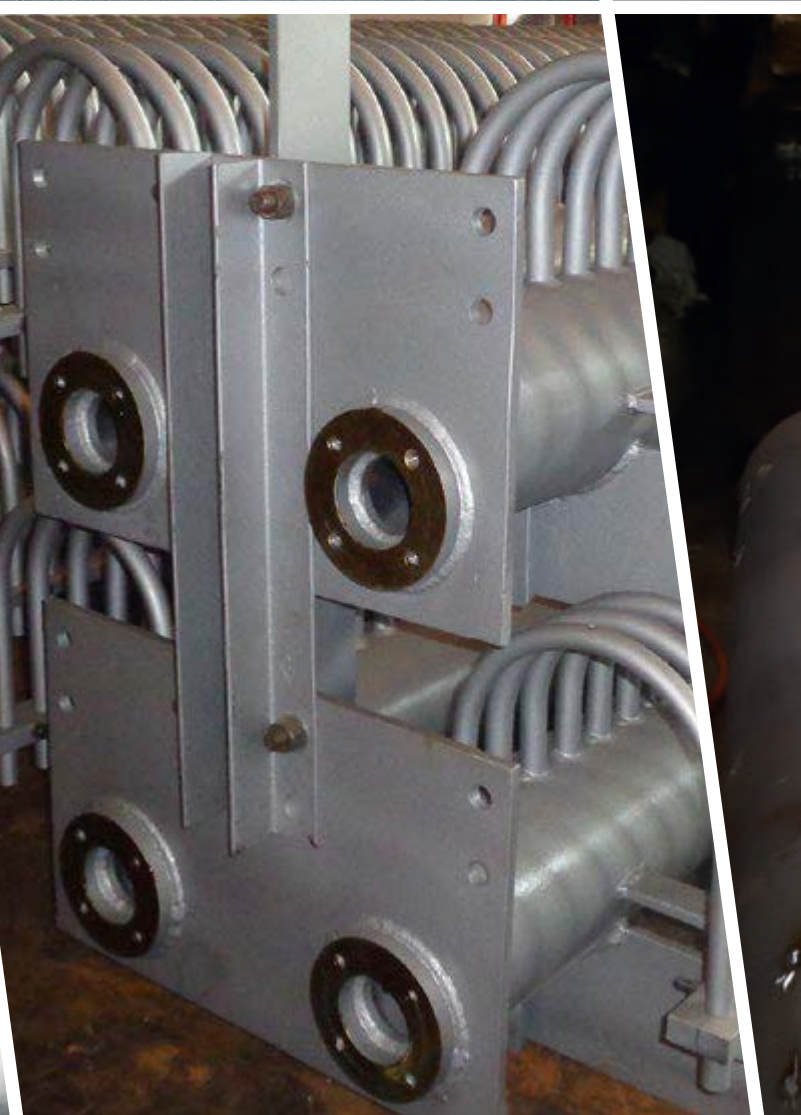
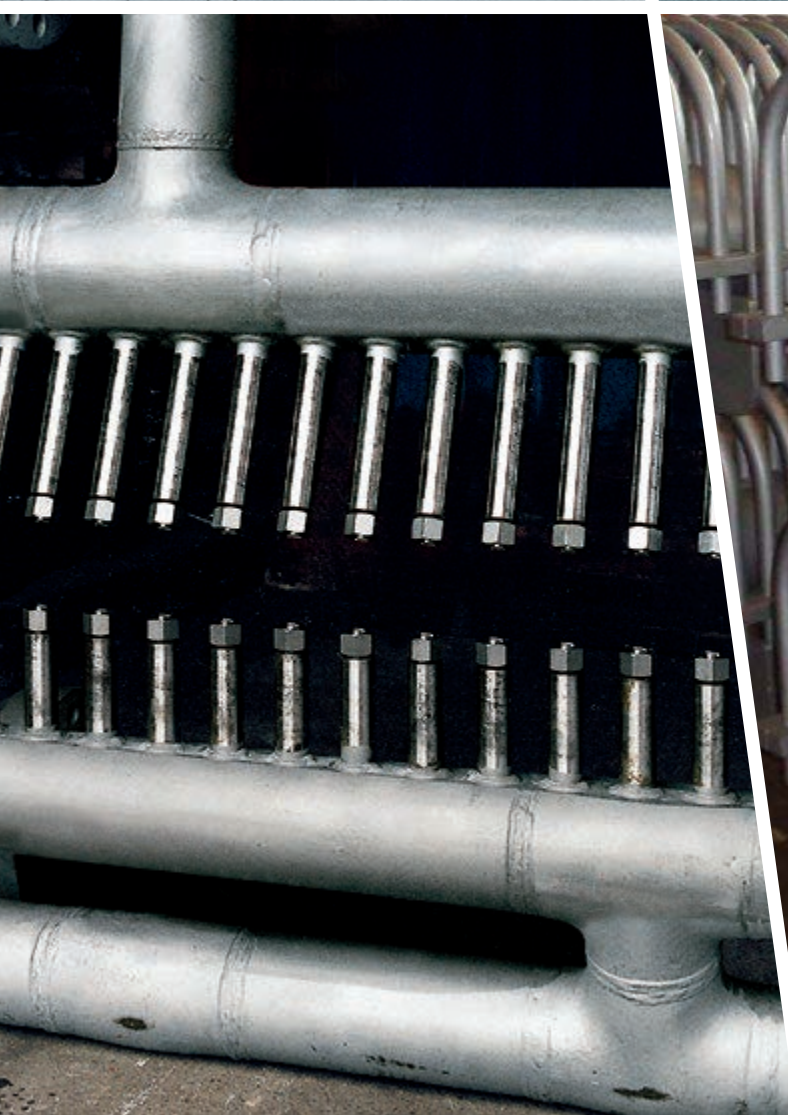



WE SHAPE LIQUIDS SO YOU CAN SHAPE STEEL

When it comes to spray technology, Lechler is the leading partner of the metallurgical industry. "ENGINEERING YOUR SPRAY SOLUTION" is our claim, which we take very seriously. Our focuses here are energy efficiency, productivity and product quality optimizations of existing plants and machinery. Innovative spray solutions from Lechler for the new generation of machines are the result of the technology partnerships with the leading plant engineering companies.





THE THREE CORNERSTONES OF LECHLER SPRAY HEADERS

Spray engineering is not ~~only~~ limited to nozzles, ~~in fact~~, the optimal nozzle arrangement on spray headers or lances is as important as the selection of the correct nozzle. Spray nozzle installations in continuous casters, rolling mill, processing lines or in gas cleaning around the world have been designed using Lechler's proven software models for spray applications.

Our spray headers –
more than
pipes and nozzles

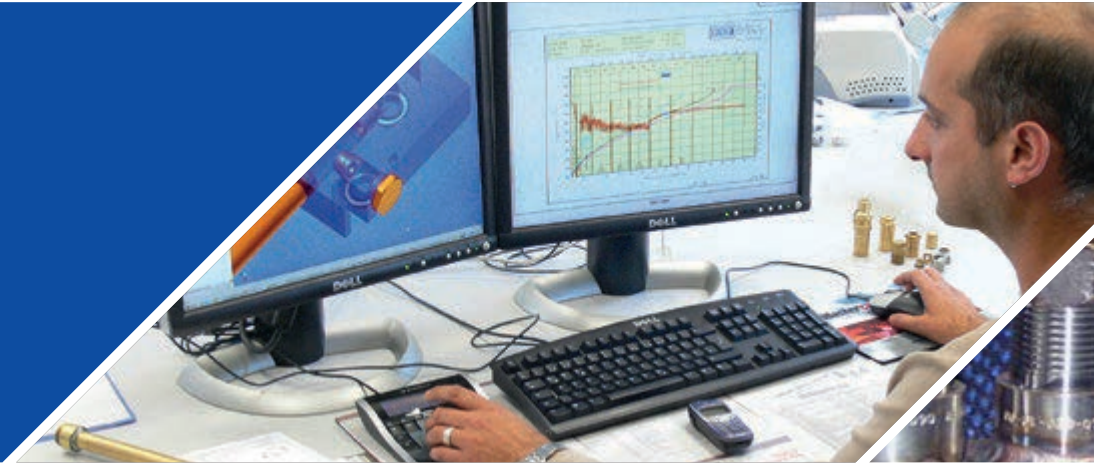

1. PROCESS KNOW-HOW

Decades of experience in successful planning and execution of projects in the metallurgical industry. Experienced engineers carry out mill studies and optimization proposals utilizing Lechler application software models.

It was only evident for Lechler to offer engineering and fabrication of spray headers, too. With this service, the circle is now complete, starting from the development of the spray nozzle, to measuring the spray performance over the application engineering and finally the apparatus carrying the spray nozzles, such as spray headers or lances.



2. CRAFTSMANSHIP

Lechler wholly owned header engineering and fabrication facilities in India, USA, China and England serving the metallurgical industry. Process industry standard engineering, fabrication and QA procedures securing correct nozzle alignment for best spray result.

3. NOZZLE PORTFOLIO

Europe's No. 1 manufacturer of spray nozzles and technology partner offering the metallurgical industry with a wide variety of spray nozzles, standardized or tailored, for every process.



THERE IS NO SHORTCUT WHEN IT COMES TO QUALITY

Customers who demand an optimal spray result are leaving it to Lechler that every nozzle is perfectly aligned and positioned on a spray header. This goes for both, header manufacturing according to a customer drawing, and for headers engineered by Lechler.

Transparent processes, audited and certified by world leading plant engineering companies, Lechler spray headers and other fabricated structures undergo dedicated QA procedures from production planning, dimensional control prior and during fabrication, NDA-testing to factory inspection reporting (FIR), packing and shipping.

OUR PROCESSES

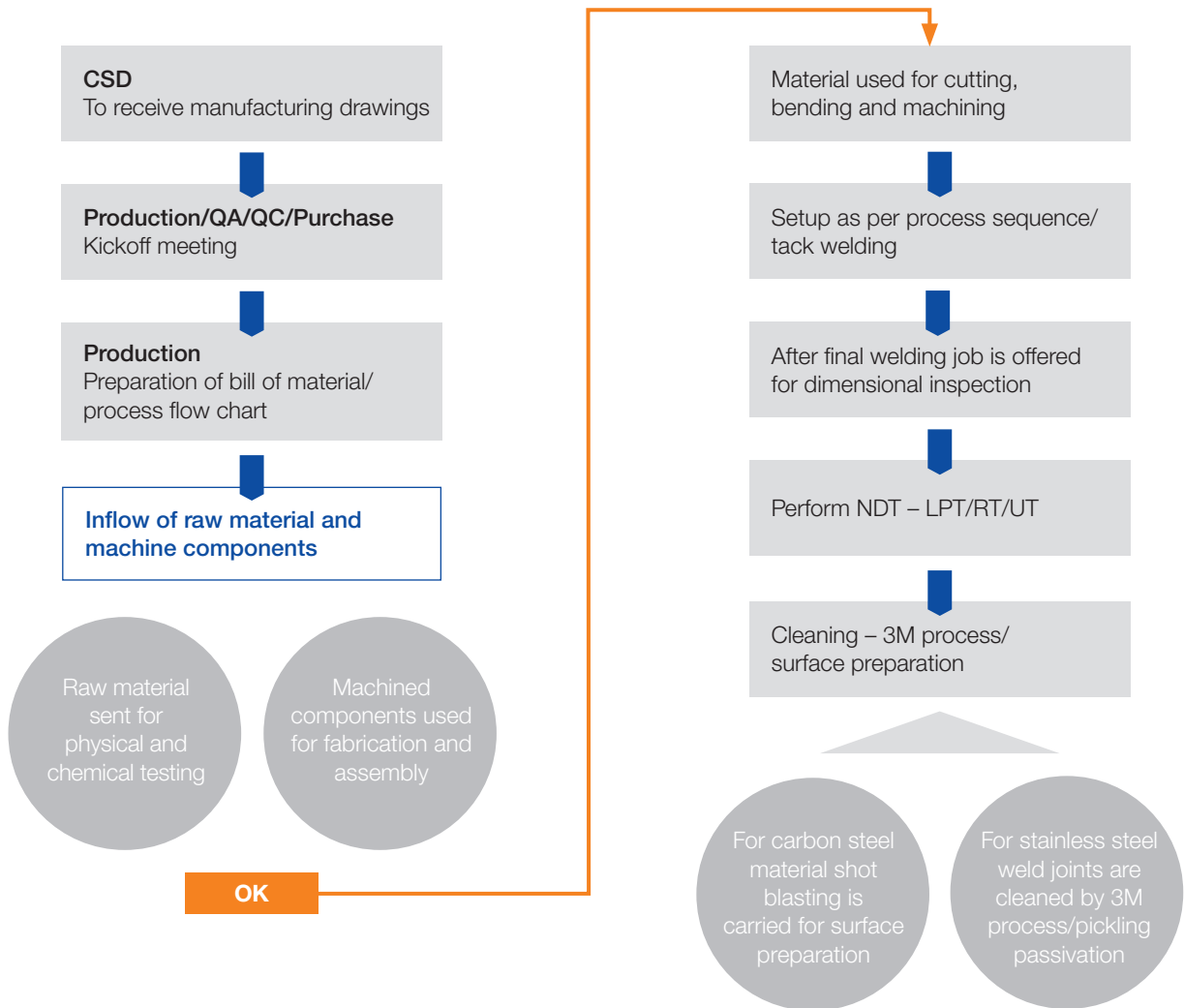

YOUR BENEFITS

Header and nozzles out of one hand

- Reduced number of suppliers
- Fewer project interfaces to coordinate

Optimized spray header design from the nozzle experts due to

- Process know-how
- Nozzle application know-how

Guaranteed overall spray performance

- Welding nipples and bases welded correctly
- Perfect nozzle alignment

Product quality and plant availability

- Approved and certified NDT and QA procedures
- Guaranteed overall spray performance

- Headers engineered and manufactured by Lechler

- Header manufactured according to customer drawings

Final inspection for painting/DFT and assembly

QA/QC clearance – packing

Dispatch

OUR WELDERS ARE ON FIRE

The welding process in header manufacturing depends on the header design and material of construction. Based on the competence and experience with those special processes and their specific requirements, Lechler ~~is assuring~~ the high quality of every weld.

The Lechler engineers, welders, NDT personnel, welding inspectors and welding coordinators ~~do~~ receive frequent training according to international standards and ~~do~~ meet all required qualifications. Independent bodies are providing the welding certifications in accordance under high compliance standards.

WE'VE GOT THE TOOLS

FOR PERFECT RESULTS

SMAW Welding

Shielded Metal Arc Welding (SMAW) is the most popular welding process often used to weld carbon steel, low and high alloy steel, stainless steel and cast iron. It is a manual arc welding process that uses a consumable and protected electrode of a proper composition for generating arc between itself and the parent work piece.



TIG Welding

Tungsten Inert Gas (TIG) welding affords greater control over the weld area than other welding processes. TIG Welding is ideal for high quality and precision welding. It is often used to make root or first pass welds of piping of various sizes.



MIG Welding

Metal Inert Gas (MIG) welding is a versatile technique that uses a continuous solid wire electrode heated and fed into the weld pool from a welding gun. It is used for continuous welding of thick and thin section components. Being a semi-automatic process it provides a uniform and also a slag free weld bead.





LET'S ~~PUT YOUR PEACE OF MIND~~ ON PAPER

As important as welding itself are the methods and processes of nondestructive testing NDT of the material, the welds and the final header. Either performed according to customers special QA specifications or according to the internal Lechler NDT standards, no header is leaving a Lechler factory without a test certificate.

HYDRO TESTING

Components such as piping systems, pressure vessels are tested for strength and leaks by hydro testing. Hydro test is carried out after completion of all fabrication work. Calibrated gauges are used for hydro testing which is carried out as per hydro test procedure.



RADIOGRAPHIC TESTING

Radiography (X-ray) uses X-rays and gamma-rays to produce a radiograph of a specimen, showing any changes in thickness, defects (internal and external), and assembly details to ensure optimum quality in operation. It is mainly used for volumetric inspection to find both surface and sub-surface defects. Radiographed film is evaluated by qualified professionals to take corrective measures.

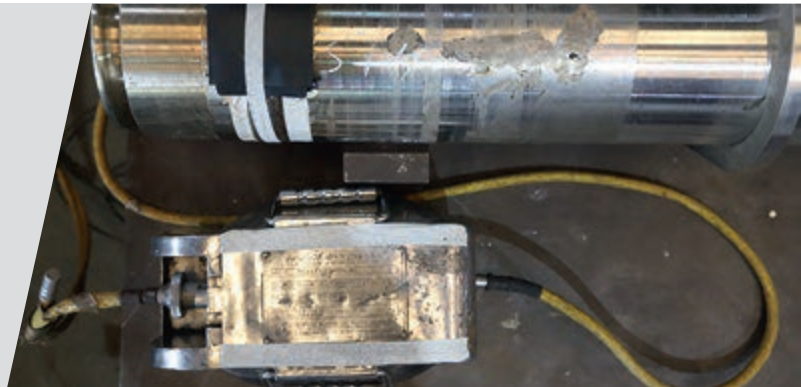

ULTRASONIC TESTING

In this process high frequency sound waves are transmitted into a material to identify changes in the material properties. Ultrasonic testing uses sound waves to detect crack and defects in parts and materials. Ultrasonic testing is often performed on steel and other metals and alloys. This process has greater accuracy than other non-destructive methods. Operators are trained to set up a test with the aid of appropriate reference standards and properly interpret the results.

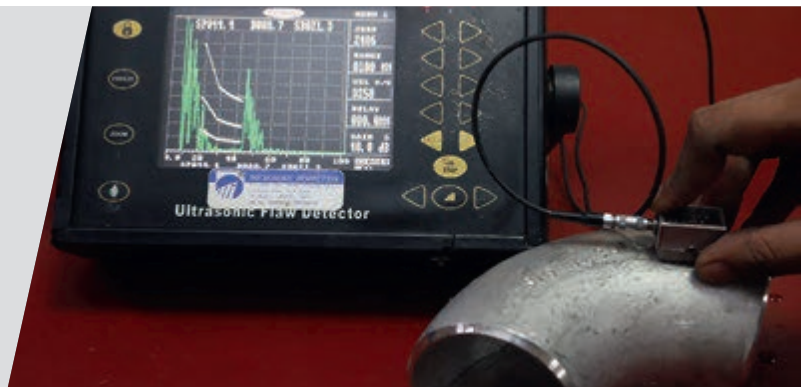

LIQUID PENETRANT TESTING

This method is used for detecting surface discontinuities. LPT is used to detect casting, forging and welding surface defects such as hairline cracks, surface porosity, leaks in new products, and fatigue cracks on in-service components. The process involves activities like pre-cleaning, application of penetrant, application of developer, inspection and post cleaning carried out by trained operators and inspectors.





~~LET'S GET SOLID:~~ SPRAY HEADERS FOR SECONDARY COOLING IN CONTINUOUS CASTING

Examples of headers made by Lechler for secondary cooling zones in continuous casting machines for steel.

Billet casters

"Banana" curved headers for billet caster made from stainless steel square pipes.



Slab caster segment with new headers

Air mist cooling headers re-engineered and manufactured by Lechler as a result of a secondary cooling optimization study.



Segment piping for slab caster

Air mist cooling headers designed and manufactured by Lechler ready for shipment to customer.

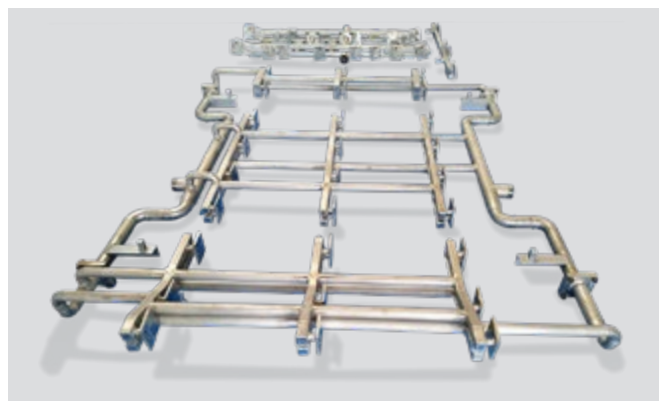

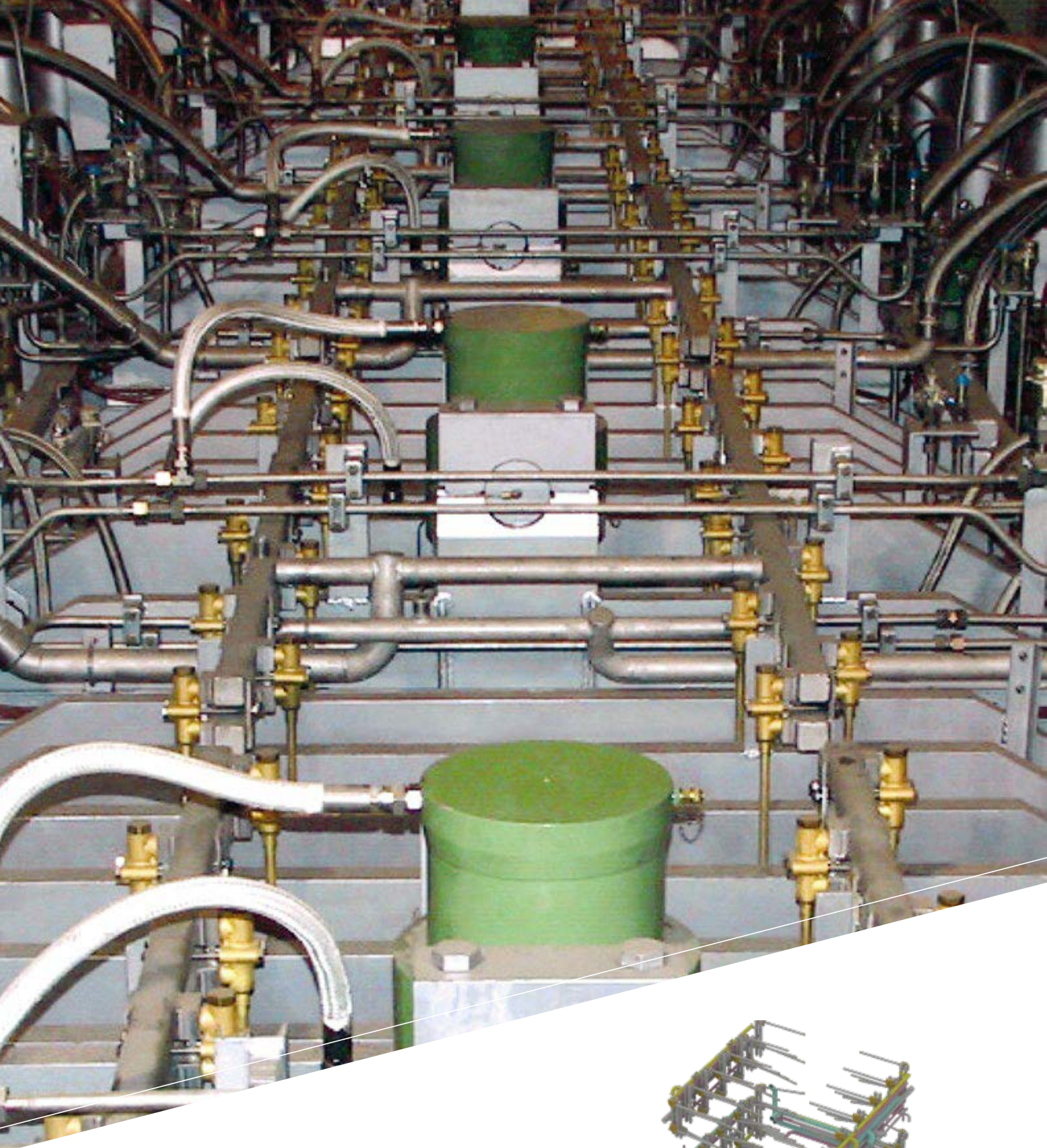

3D view of on-board piping of slab caster segment

- Lechler Mastercooler SMART air mist nozzles
- Optimized piping and secondary cooling layout with separate spray width control zones
- Vertical nozzle piping for Mastercooler SMART connection behind segment main frame

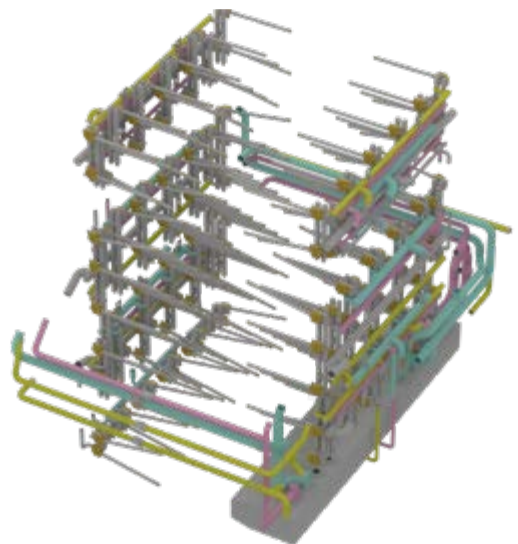



Example of a descaling spray header

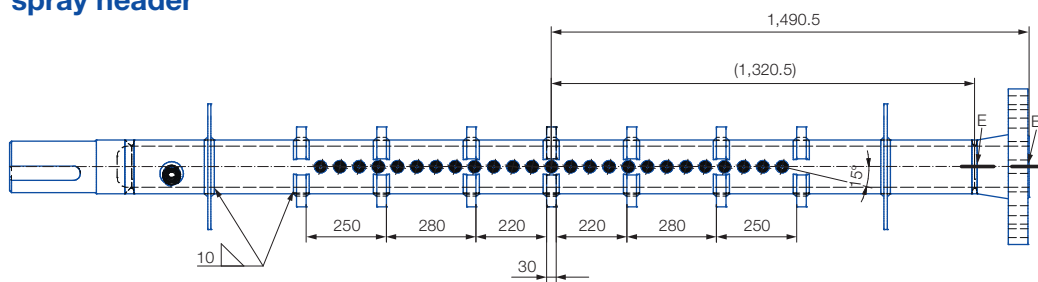



NO COMPROMISES TOLERATED DESCALING HEADERS FOR HOT ROLLING

Lechler descaling headers for all steel hot rolling processes: Plate, hot strip, bar and bloom, pipe, and beam blank.

Beam blank rolling mills

Special descaling header design for a beam blank with identical spray height at flanges, tips and web.

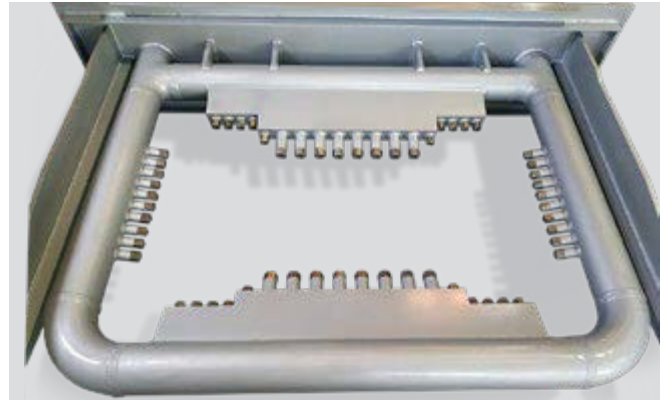

Plate and hot strip mills

Bottom descaling header for a 5,000 mm plate mill descaler.



Seamless pipe mills

Descaling header for a seamless pipe mill. Configuration with Lechler Descale application software.





~~FLAT OUT FOR QUALITY:~~ SPRAY HEADERS FOR HOT AND COLD ROLLING

Long product rolling mills

Roll cooling headers for bar and merchant mill.



Hot strip mills

Roll cooling header for a wide hot strip mill made from stainless steel.



Plate mills

Roll cooling header for a 5,000 mm plate mill in carbon steel painted according to customers' specification.

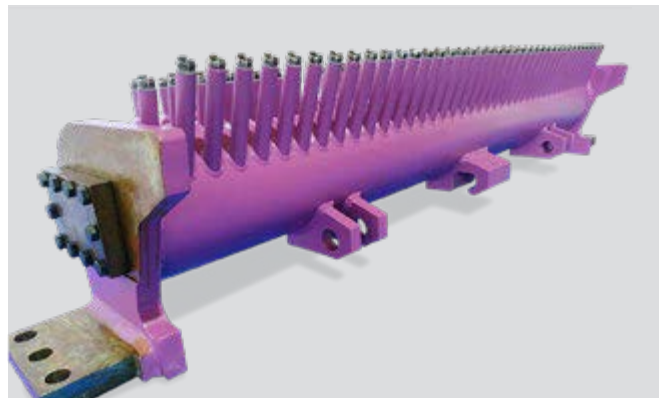



Lechler SELECTOSPRAY selective roll cooling for AFC in cold rolling of steel and NF-metals

- Each nozzle controlled by Lechler spray valve
- Modulax valves pneumatically actuated
- EVA valves electrically actuated
- Systems individually designed into every rolling mill
- More than 500 references

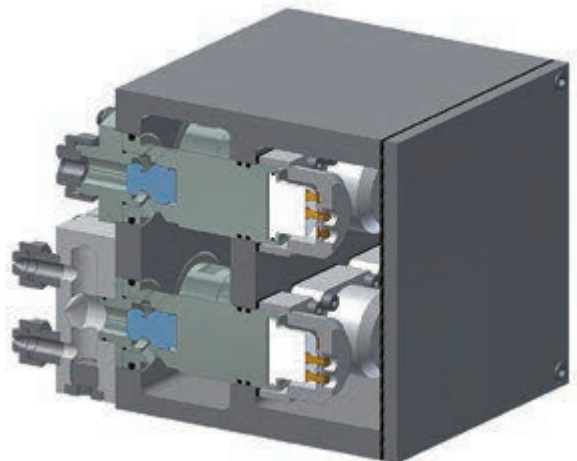

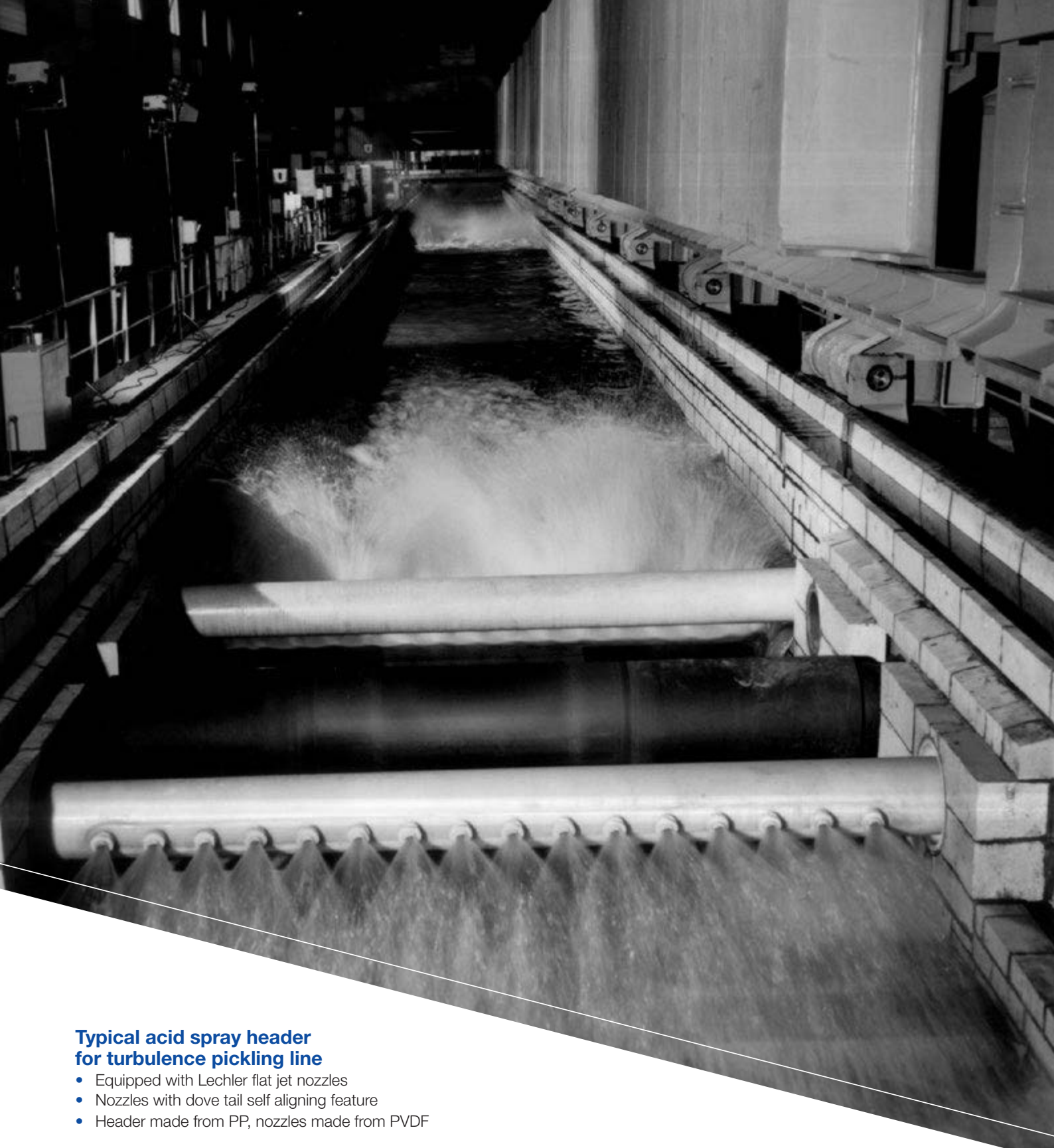

Typical acid spray header for turbulence pickling line

- Equipped with Lechler flat jet nozzles
- Nozzles with dove tail self aligning feature
- Header made from PP, nozzles made from PVDF

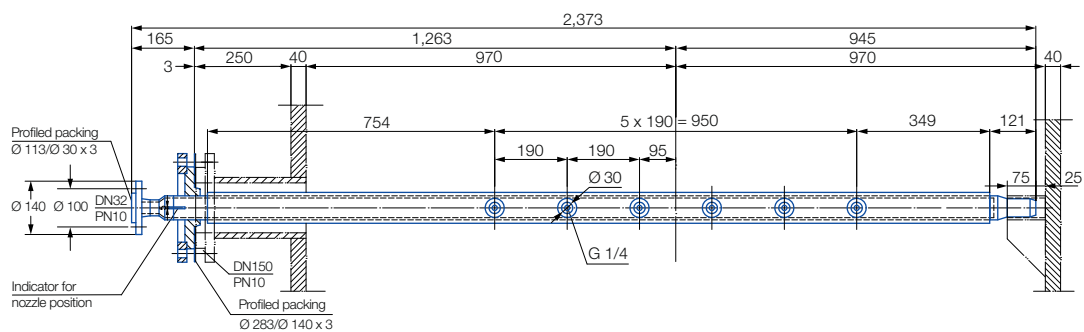



~~EVERYTHING~~ BUT SUPERFICIAL: SPRAY HEADERS FOR PROCESSING LINES

Washing, pickling acid spraying, rinsing, washing, cooling, strip edge drying. Those are the most common spray applications in processing lines for strips and wire. Headers made from stainless steel or from various plastic materials for all types of processing lines, Lechler can do it all.

Plastic headers

Typical rinsing headers of a steel strip pickling line made from PP and Lechler nozzles made from PVDF.



Self cleaning Lechler STAMM showers

Clog-free operation by means of an inline cleaning brush assembly. With the simple turn of a manual or automatic handle, internal brushes clear debris from our self-aligning nozzles. Typical applications are rinsing, low or high pressure spray cleaning of strips and brushes in pickling and galvanizing lines.



Lechler air mist headers for CAP-lines

It is in the cold continuous annealing and pickling line where the treatment of the strip is performed, providing the metallurgical structure of the stainless steel.

At temperatures between 800°C and 200°C the recrystallization takes place in the furnace before the strip is cooled from top and bottom by means of air blowing, conventional water spray cooling and air mist spray cooling. Often it is a combination of all three methods. Varying steel grades and line speeds require specific cooling rates to avoid carbide precipitation at grain boundaries. The special Lechler air mist cooling header design is providing exactly that. The 1 : 10 water control ratio (turn-down ratio) allows a precise setting with perfect spray patterns from min. to max. line speeds. The large spray overlaps ensure a uniform cooling over the entire strip width for an optimal thermal homogeneity across the strip.



ENGINEERING
YOUR SPRAY SOLUTION



Lechler GmbH – Precision Nozzles – Nozzle Systems

Ulmer Strasse 128 · 72555 Metzingen, Germany · Phone +49 7123 962 0 · info@lechler.de · www.lechler.com

ASEAN: Lechler Spray Technology Sdn. Bhd. · No. 23 Jalan, Teknologi 3/3A · Kota Damansara · 47810 PJ, Malaysia · Phone +603 6142 1288 · info@lechler.com.my

Belgium: Lechler S.A./N.V. · Avenue Newton 4 · 1300 Wavre · Phone +32 10 225022 · info@lechler.be

China: Lechler (Tianjin) Intl. Trad. Co. Ltd. · Rm. 418 Landmark Tower · No. 8 Dong San Huan Bei Lu · Beijing, 100004 · Phone +86 10 84537968 · info@lechler.com.cn

Finland: Lechler Oy · Ansatie 6 a C 3 krs · 01740 Vantaa · Phone +358 207 856880 · info@lechler.fi

France: Lechler France SAS · Bât. CAP2 · 66-72 Rue Marceau · 93100 Montreuil · Phone +33 1 49882600 · info@lechler.fr

Great Britain: Lechler Ltd. · 1 Fell Street, Newhall · Sheffield, S9 2TP · Phone +44 114 2492020 · info@lechler.com

India: Lechler (India) Pvt. Ltd. · Plot B-2 · Main Road · Wagle Industrial Estate Thane · 400604 Maharashtra · Phone +91 22 40634444 · lechler@lechlerindia.com

Italy: Lechler Spray Technology S.r.l. · Via Don Dossetti, 2 · 20080 Carpiano (Mi) · Phone +39 2 98859027 · info@lechleritalia.com

Spain: Lechler, S.A. · Avda. Pirineos, 7 · Edificio Inbisa I, Oficina B7 · 28703 San Sebastián de los Reyes (Madrid) · Phone +34 91 6586346 · info@lechler.es

Sweden: Lechler AB · Kungsängsvägen 31B · 753 23 Uppsala · Phone +46 18 167030 · info@lechler.se

USA: Lechler Inc. · 445 Kautz Road · St. Charles, IL 60174 · Phone +1 630 3776611 · info@lechlerusa.com

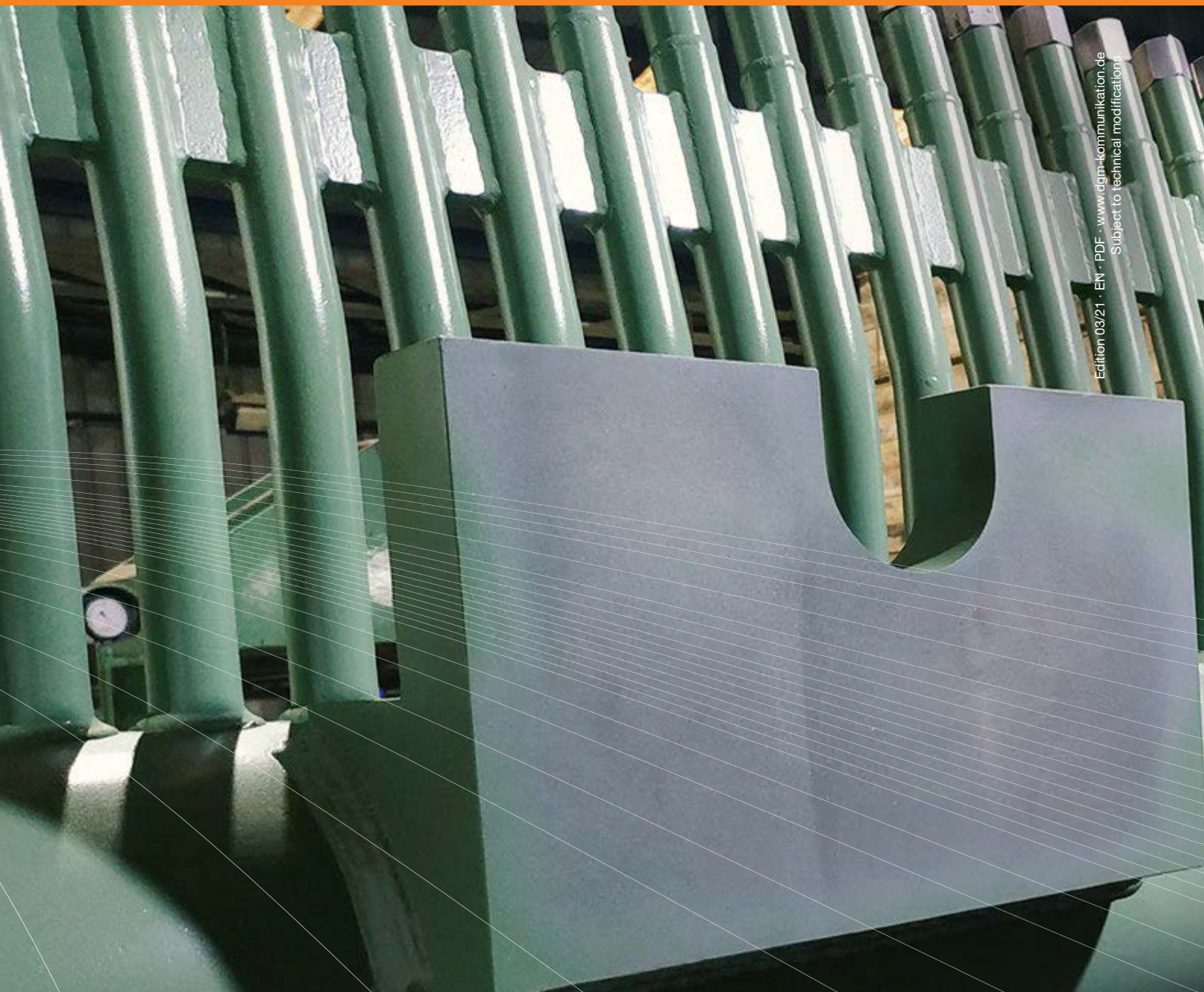

Edition 09/21 · EN · PDF · www.dgm-kommunikation.de
Subject to technical modifications