

# Multi-channel flat fan nozzles for air "Whisperblast", metal version Series 600.283.42/600.606.42

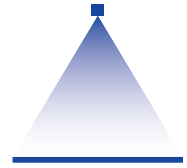

## Features:

- Laminar, powerful air stream
- High blowing force
- For high thermal and mechanical requirements

## Applications:

- Blowing off and out
- Cleaning
- Drying
- Cooling
- Transporting

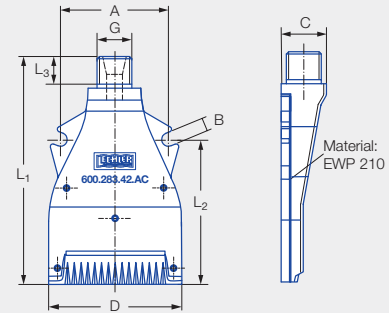

Series  
600.283.42/600.606.42

<sup>1</sup> Meets OSHA specifications in terms of noise level.

## Cost savings and noise reduction

Series 600.283/  
Series 600.606



Cost savings

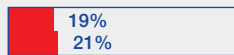

Noise reduction

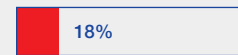

## Technical data

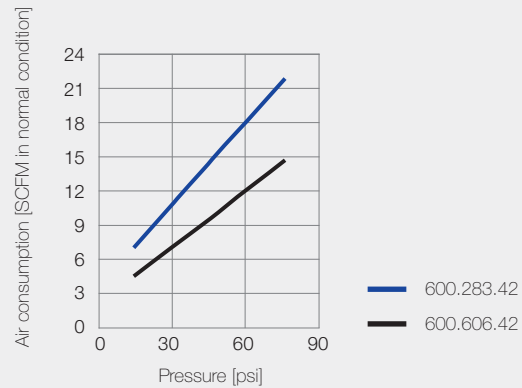
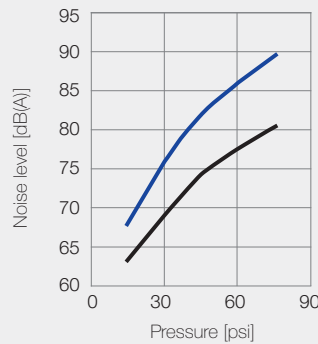
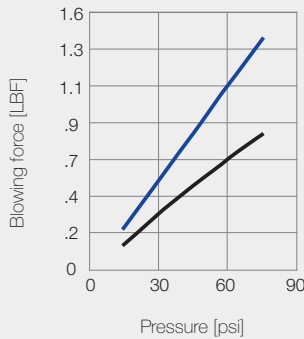

Connection	G	Dimensions [in]							Weight [lbs]
		A	B	C	D	L <sub>1</sub>	L <sub>2</sub>	L <sub>3</sub>	
AC	1/4 BSPP	1.61	0.20	0.67	2.01	3.41	2.17	.41	0.13
BC	1/4 NPT	1.61	0.20	0.67	2.01	3.41	2.17	.41	0.13

Ordering number			
Type	Material number	Connection	
	42	1/4 BSPP	1/4 NPT
	Aluminum		
600.283	●	AC	BC
600.606	●	AC	

Ordering example: Type 600.283 + Material no. 42 + Code BC = Ordering no. 600.283.42.BC



Assembly accessories can be found in Chapter 12 "Accessories".