

ENGINEERING
YOUR SPRAY SOLUTION



➤➤ TANK AND EQUIPMENT CLEANING

Cleaning diversity of the highest quality

GENERAL INDUSTRY





A CLEAN SOLUTION

140 YEARS OF HYGIENE COMPETENCE

For over 140 years, we at Lechler have been researching drops and their applications. Our nozzles ensure optimum cleanliness particularly in locations that are difficult to access, where it is dangerous or where things have to be especially clean.

With more than 700 employees, we work worldwide to provide the right nozzle for every application. With our own Development and Technology Center in Metzingen we simulate complex spray characteristics, check nozzles in endurance tests and optimize cleaning patterns so that the ideal relationship between flow rate, range and spray force is achieved.

Over the course of all these years, we have developed a deep understanding of the processes in a large number of different industries. That is why we do not just support our customers with high-performance precision nozzles for tank and equipment cleaning, but also help them to optimize their processes.

1879



Company founded
by Paul Lechler

1893



Patent for
liquid atomization

1967



Relocation of production
to Metzingen

1978













Expansion to the
USA and then to
other countries

1995



Production, sales and
administration are
concentrated in Metzingen

CONTENTS

	Introduction	4
	Fundamentals	8
	Product range	20
	Efficiency class 1	28
	Efficiency class 2	38
	Efficiency class 3	62
	Efficiency class 4	70
	Efficiency class 5	78
	Perfect add	88
	Maintenance	104

140

1879 - 2019

2010



Expansion of production with a new, 13,000 m² production hall

2016



Opening of the state-of-the-art Development and Technology Center in Metzingen

2019



Lechler celebrates 140th anniversary

2021



New factory in China

2022



New logistics center in Metzingen

2023



Start of construction of the new Lechler Campus



EVERY DROP ON TARGET HOW WE HELP TO CLEAN UP AGAIN

An excellent understanding of cleaning processes, tank geometries and nozzle design is required in order to achieve optimum cleaning of tanks and equipment. We have been at home in all three fields for a long time now. But there are still always new challenges for us. Thanks to state-of-the-art CFD analysis and highly precise measuring instruments for drop sizes and speeds, we are quickly able to develop suitable solutions in these cases.

With our proprietary *TankClean* software, we are also able to simulate complex tank geometries and spray processes with different nozzles. Together with our extensive range of cleaning nozzles, we can develop tailor-made solutions for your tank and equipment cleaning requirements – particularly if complex applications are involved.

Why Lechler?

- Unique product variety of the market leader
- Cleaning efficiency classes – for easy nozzle selection
- Planning security thanks to *TankClean* simulation software
- Solutions for agitator, filler neck and line cleaning
- Extensive accessories for complete solutions
- Individual advice – on-the-spot worldwide
- Short delivery times thanks to high stock availability







MORE THAN JUST NOZZLES OUR COMMITMENT TO TANK AND EQUIPMENT CLEANING

Effective tank and equipment cleaning cannot just be limited to the tanks. Lechler therefore offers a comprehensive and coordinated product range to allow fast, efficient and thorough cleaning from the feed lines through to the discharge lines.

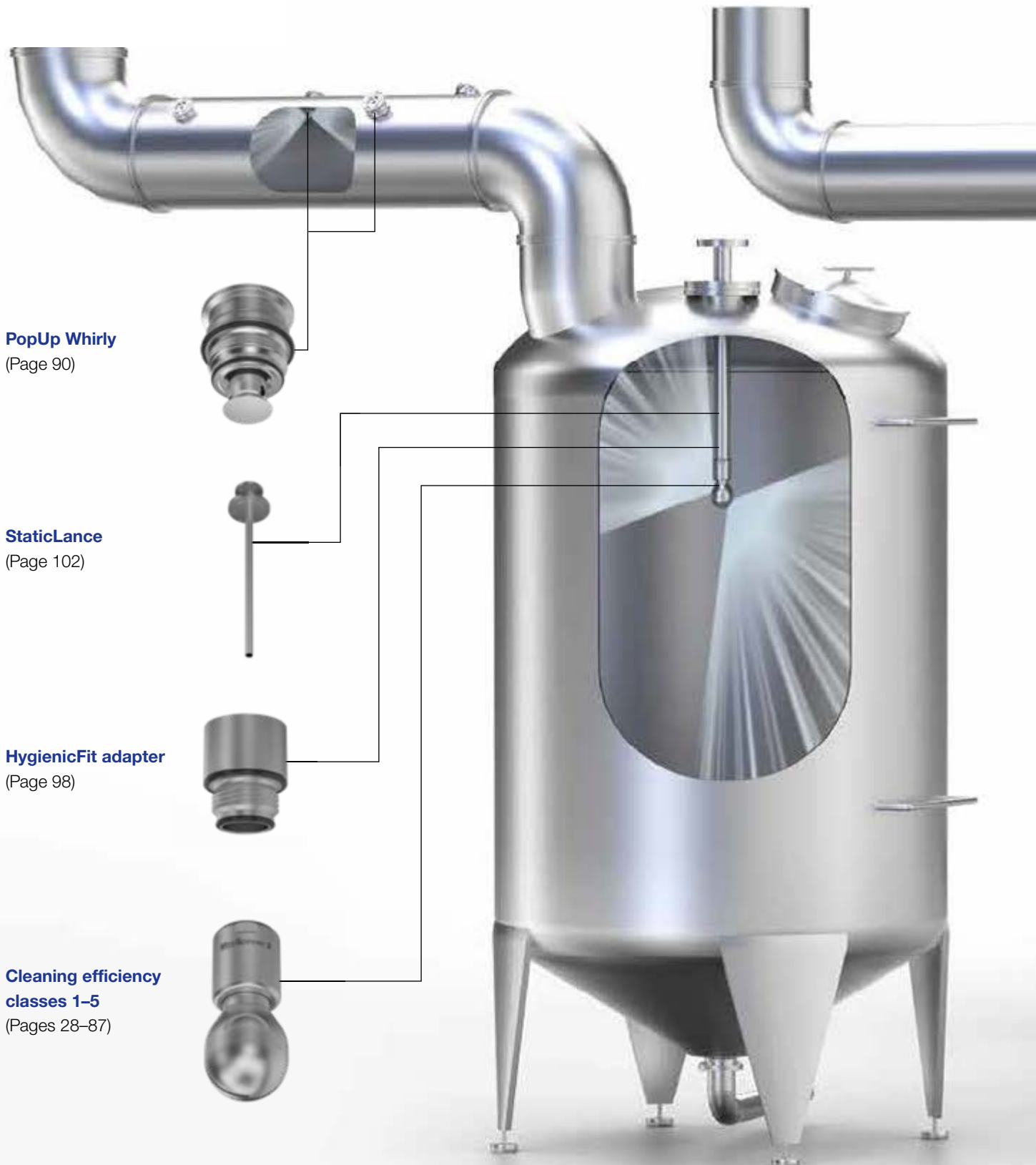

PopUp Whirly
(Page 90)

StaticLance
(Page 102)

HygienicFit adapter
(Page 98)

**Cleaning efficiency
classes 1–5**
(Pages 28–87)

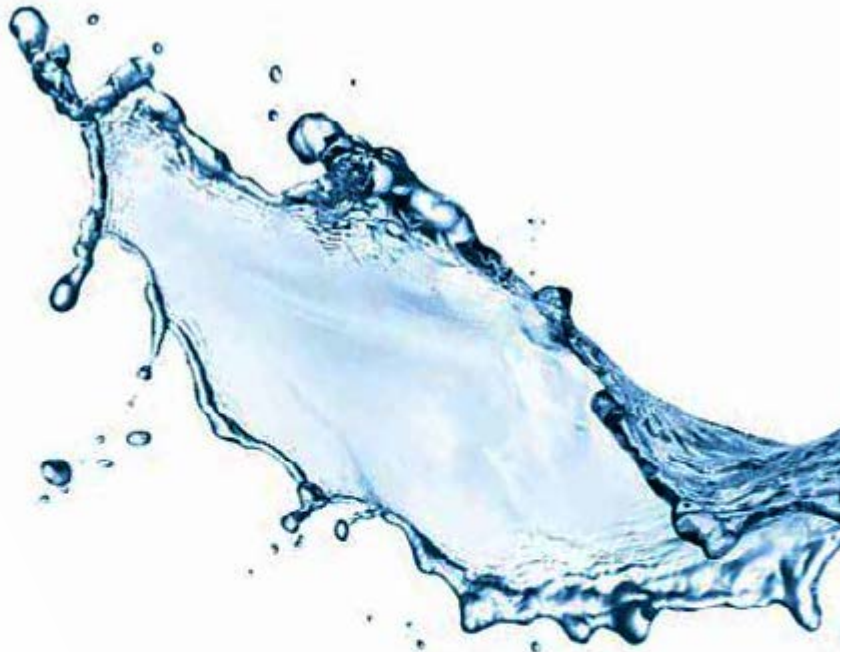

FlexLance
(Page 103)



Rotation monitoring sensor
(Page 100)



Cleaning efficiency classes 1–5
(Pages 28–87)



PopUp Clean
(Page 94)

GIVE DIRT NO CHANCE TIME TO GET CLEANING

Nobody likes dirt or contaminations: they impair product quality. But removal takes time – and causes costs.

As your partner, we help to minimize these costs as much as possible.



This is how efficient cleaning works – Sinner's circle

Every cleaning process is based on four main factors:

- Chemical (choice and concentration of the cleaning agents)
- Mechanical (detachment of dirt by impact or shear stress)
- Temperature (at which cleaning takes place)
- Time (duration of the overall cleaning process)

The four cleaning factors can be clearly demonstrated by Sinner's circle. Together, they always result in 100% of the cleaning effort. Depending on the cleaning process, the individual factors may be of different magnitudes and they mutually influence each other. The cleaning nozzle directly influences the mechanical factor.

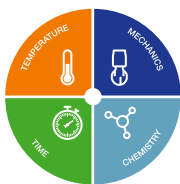
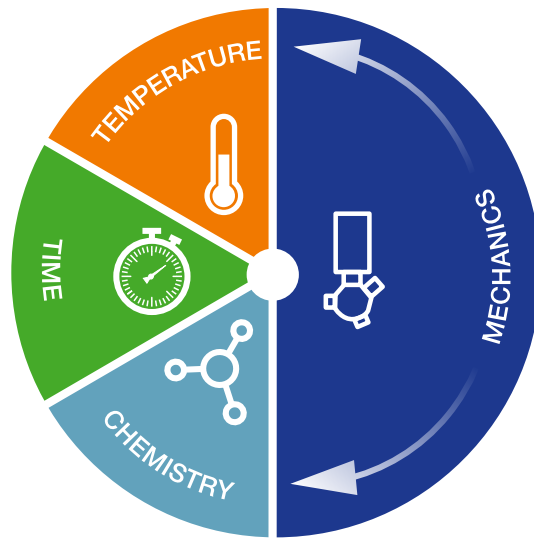
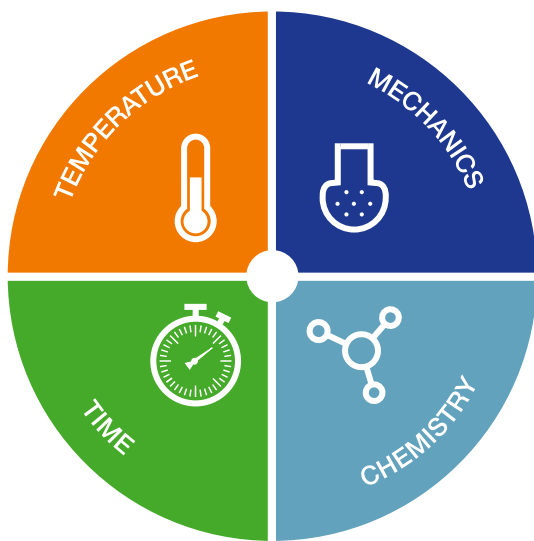

Fig. 1

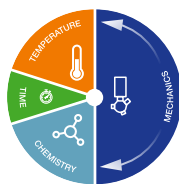

Fig. 2

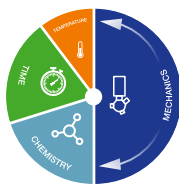
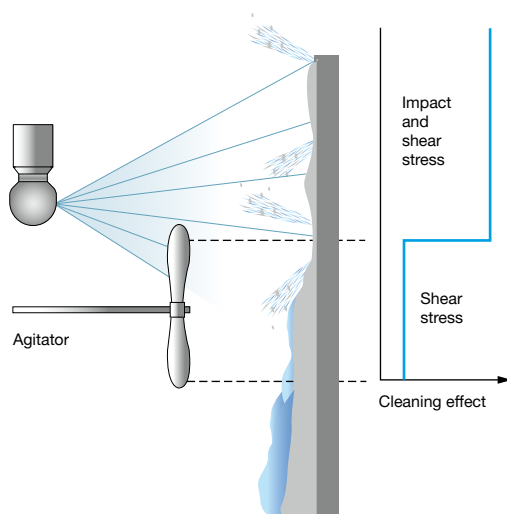

Fig. 3

Example

Assumption: A given tank can be successfully cleaned with equal shares for the time, temperature, chemical and mechanical factors (Fig. 1). Choosing a different nozzle with more powerful cleaning force results in additional freedom for cleaning faster (Fig. 2) or with a lower temperature (Fig. 3) and thus more energy-efficiently, for example.



Cleaning by impact only occurs
if it takes place directly

If a jet is sprayed on to a surface, this generates an impact. This direct impact leads to a better cleaning effect. As a result of shear forces or shear stresses produced by the cleaning fluid as it runs down, areas that are not impacted directly are also rinsed. However, the cleaning effect there is much weaker in comparison with direct impact.

Important: The best cleaning effect is obtained by high impact at the location to be cleaned.

Cleaning in the low pressure range (2 bar to 5 bar) is normally most effective and efficient. This is because normally larger tanks are cleaned and higher pressures would lead there to a high level of atomization with a reduced cleaning effect. Lechler offers high pressure tank cleaning machines for cleaning small tanks with the most persistent soiling.

Good to know

The impact is sufficient for a rough assessment of the cleaning force. However, things are often much more complex in practice. In specific applications, it is sometimes possible to realize additional savings by conducting a more detailed analysis. Talk to us. We will gladly advise you: by phone on +49 7123 962-0 or by email at info@lechler.de.



QUICK DECISION-MAKING AID

LECHLER CLEANING EFFICIENCY CLASSES

Our promise: Lechler has the right cleaning nozzle for every application. We have separated our extensive range of nozzles into five different cleaning efficiency classes so that you can easily find the product that is right for your application. Below you will find the typical soiling types for the respective efficiency class. Here, the higher the efficiency class, the more powerful and efficient the mechanical cleaning effect (see page 8, Sinner's circle).



1

Possible soiling type



- Type** Spray ball, static
- Cleaning effect**
- Drive** No drive, no rotating parts
- Typical soiling** Light soiling such as non-adhering powder or liquids
- Nozzle design** Static spray pattern with punctiform impact



2

Possible soiling type



- Type** Rotating cleaner, free-spinning
- Cleaning effect**
- Drive** By the medium
- Typical soiling** Low-viscosity to slightly viscous substances such as fresh ketchup
- Nozzle design** Slot design or bore layout with direct impact on the entire tank surface



3

Possible soiling type



- Type** Rotating cleaner, free-spinning
- Cleaning effect**
- Drive** By the medium
- Typical soiling** More viscous substances such as chocolate sauce
- Nozzle design** Special flat fan geometry with direct impact on the entire tank surface

Good to know

The individual cleaning efficiency classes are not sharply defined. Depending on application, nozzles from the next-higher or next-lower cleaning efficiency class may be suitable. Please ask us in case of doubt. We will gladly advise you: by phone on +49 7123 962-0 or by email at info@lechler.de.

4



Possible soiling type



- Type** Rotating cleaner, controlled rotation
- Cleaning effect** 
- Drive** By the medium, drive unit with turbine and gear unit
- Typical soiling** Medium soiling such as high-viscosity creams
- Nozzle design** Special flat fan nozzle inserts with direct impact on the entire tank surface

5

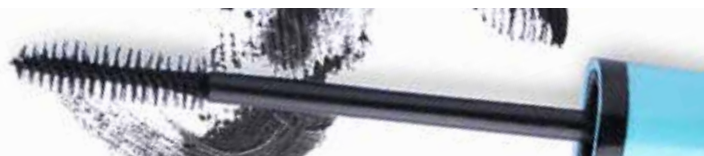

Possible soiling type



- Type** High impact tank cleaning machine
- Cleaning effect** 
- Drive** By the medium, drive unit with turbine and gear unit
- Typical soiling** Persistent soiling such as make-up
- Nozzle design** Solid stream nozzles with controlled rotation about two axes, direct impact on the entire tank surface during a cleaning cycle

5 HIGH PRESSURE



Possible soiling type



- Type** High pressure tank cleaning machine
- Cleaning effect** 
- Drive** Electric motor
- Typical soiling** Most persistent soiling such as dried dough in small tanks
- Nozzle design** Solid stream nozzles with controlled rotation about two axes, direct impact on the entire tank surface during a cleaning cycle



OPERATING PRINCIPLES DESIGN AND CLEANING CAPACITY

Different operating principles influence the impact and the cleaning effect. The cleaning efficiency can also be influenced by choosing the appropriate nozzle.

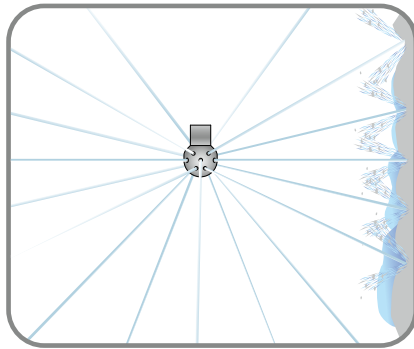

Spray ball, static

Static spray balls do not have any moving parts and are largely maintenance-free.

- The impact of the spray jets is punctiform and the surfaces are cleaned by the shear stress of the liquid running down the surface.
- The water consumption is comparatively high
- Increasing soiling results in a significantly longer cleaning time, and cleaning may not be complete
- Simple, inexpensive solution

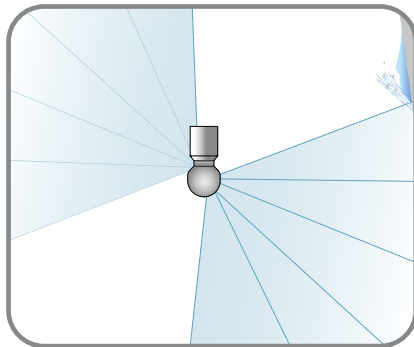

Rotating cleaner, free-spinning

Thanks to their special nozzle geometry, free-spinning rotating cleaners permit area impact on the tank walls. They are particularly suitable for small to medium-sized tanks.

- Drive by cleaning fluid
- Fast impact repetition
- Optimum cleaning performance in the low pressure range

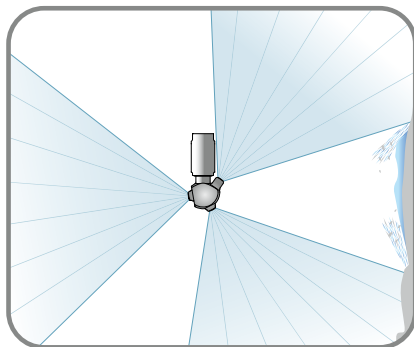

Rotating cleaner, controlled rotation

These rotating cleaners are characterized by their controlled rotation and a stronger cleaning effect thanks to special flat fan geometries. They are particularly suitable for medium-sized to large tanks.

- Increased impact thanks to low rotation speed and resultant larger drops
- Optimum cleaning performance in medium pressure ranges

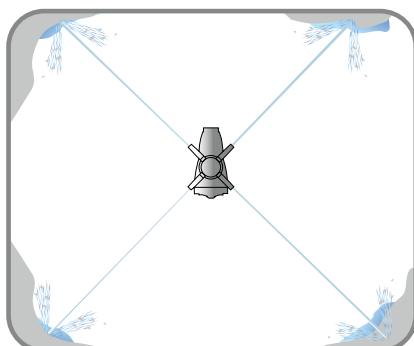

High impact tank cleaning machines, controlled rotation about two axes

High impact tank cleaning machines operate with few solid streams for maximum impact. The rotation of the nozzles about two axes means that every point on the tank wall is hit by the streams during the cleaning cycle.

- Punctiform impact over the entire tank surface
- Maximum impact
- Highest cleaning power

A few rules of thumb

Flow rate and impact

The higher the flow rate, the greater the impact and the more intensive the cleaning effect. For the best possible results, the nozzles with the highest flow rate should be chosen from the suitable nozzles within a series.

Operating pressure

The best results can be achieved with the recommended operating pressure of the respective nozzle. An excessively high pressure leads to greater atomization and reduces the spraying range.

If there is more than one flow rate size within a series, the types with the largest and smallest spraying range are shown. If other flow rate sizes are available, their comparable curves run between the shown upper and lower limits. Information on the maximum tank diameter is provided in the table on the respective product page.

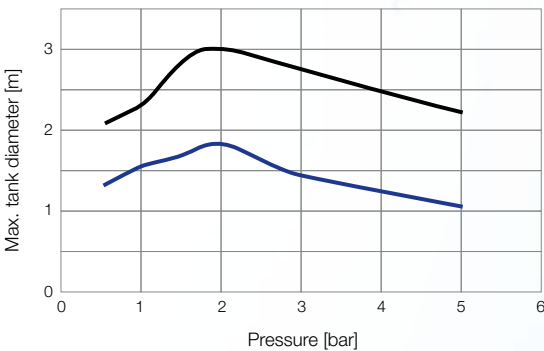

Cleaning cycle time

Rotating cleaners of cleaning efficiency classes 2 to 4 achieve fast, full-area impact in one revolution.

In contrast, high impact tank cleaning machines need several revolutions to complete a cleaning cycle. High impact tank cleaning machines of cleaning efficiency class 5 spray the tank wall in a defined pattern with their powerful solid jets. A certain number of revolutions of the high impact tank cleaning machine is needed to cover every point in the tank. The time required for this is referred to as “Cleaning cycle duration”.

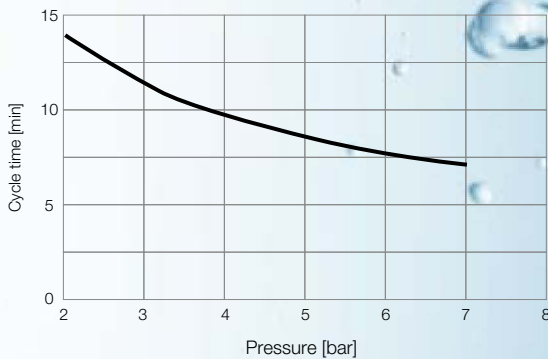

Good to know

There is at least one exception to every rule of thumb. If you are unsure or need further support, make life easier for yourself and just ask us. You can contact us by phone on +49 7123 962-0 or by email at info@lechler.de.



FOR YOUR PLANNING

CRITERIA FOR NOZZLE SELECTION

The size of the tank, its shape and possible fittings are important factors for selection of the right cleaning nozzle. Fittings in particular determine the number of nozzles required for optimum cleaning.

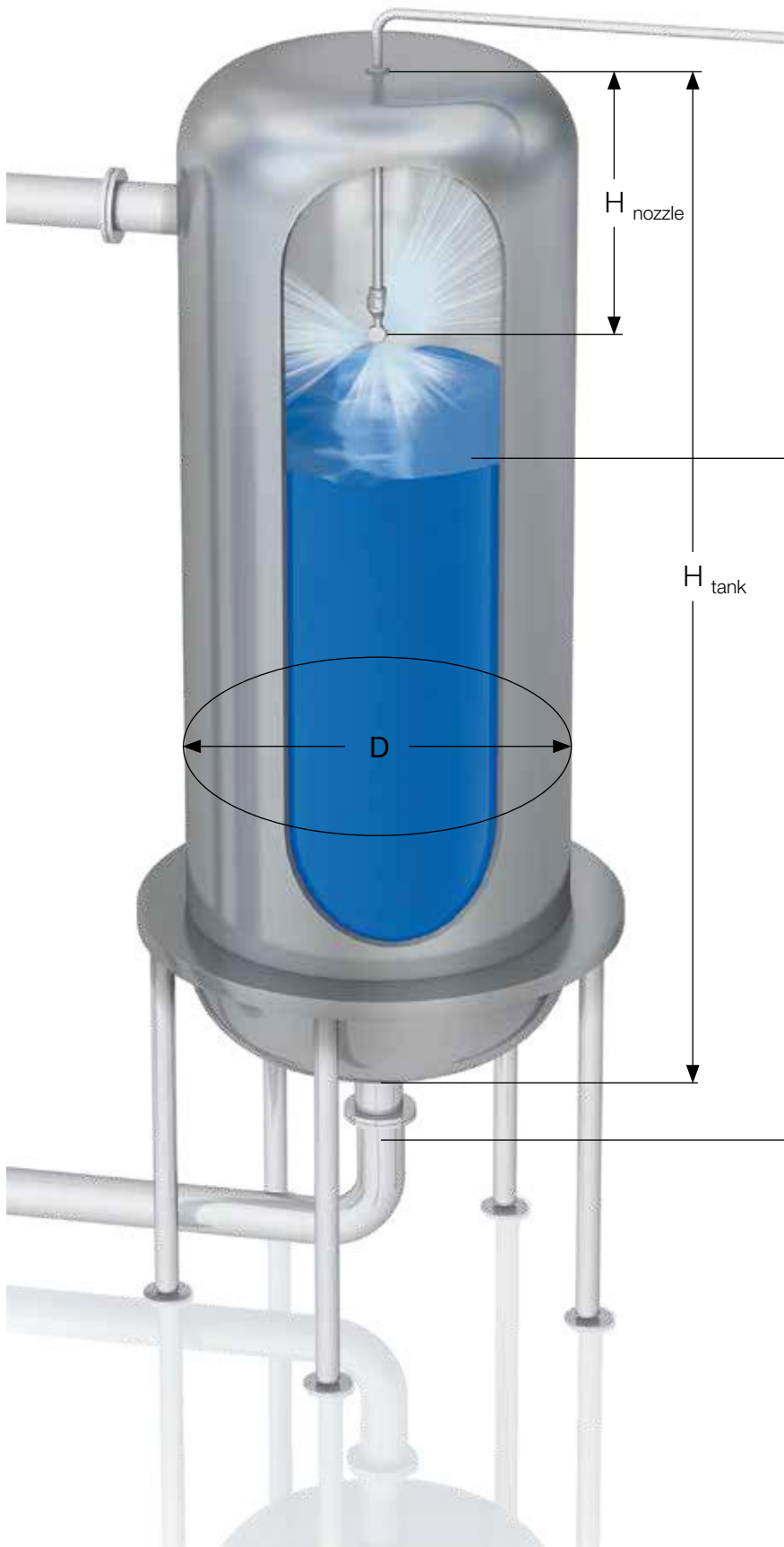

Tank size

The diameter of the tank to be cleaned should be smaller than the maximum tank diameter recommended in the product tables. You can find the necessary information on the product pages.

Fill level

If possible, the nozzle should not come into contact with the product during production. It is therefore recommended to install nozzles above the maximum tank fill level.

Arrangement

The nozzle must be positioned in the upper part of the tank if possible. The following recommendation applies:

$$H_{\text{nozzle}} = \frac{1}{3} \cdot H_{\text{tank}}$$

Make sure that sufficient cleaning fluid strikes the tank ceiling.

$$H_{\text{nozzle}} < \frac{1}{3} \cdot D_{\text{max. nozzle}}$$

Conversion

Flow rate according to density:

If the density of the cleaning agent (R) differs from that of water (W), the flow rate is calculated as follows:

$$\dot{V}_R = \dot{V}_W \sqrt{\frac{\rho_W}{\rho_R}}$$

Flow rate according to differential pressure:

If the tank cleaning nozzle is operated with a deviating differential pressure, the flow rate is calculated as follows:

$$\dot{V}_2 = \sqrt{\frac{p_2}{p_1}} \cdot \dot{V}_1$$

Differential pressure according to volume flow:

$$p_2 = \left(\frac{\dot{V}_2}{\dot{V}_1}\right)^2 \cdot p_1$$

Tank drainage rate

The tank drainage rate must be chosen so that the liquid level does not rise during the cleaning process. The following values are recommended.

Drain ["]	Drainage rate [l/min]
1	23
1 1/2	50
2	87
2 1/2	132
3	190
4	330



Number of nozzles

When cleaning large tanks or complex installations, it is often necessary to install several nozzles. They must be positioned so that their spray jets overlap and that the jets strike every surface that is to be cleaned if possible.

Avoidance of spray shadows

Obstacles such as agitators, baffle plates or pipes can prevent the areas behind them from being reached directly by the spray jet. Impact cleaning is not possible there. In such cases, it is necessary to install several nozzles so that the spray shadows of the individual nozzles are eliminated. In addition, static spray nozzles can also be used for targeted removal of deposits left as a result of spray shadows or in areas that are difficult to clean.

Pump and pipes

The pipe dimensions depend on the flow rate to be delivered. The size should be chosen so that the pressure losses in the feed pipe system are kept as low as possible. The required static operating pressure must be present directly at the nozzle. The pump power must be matched to this.



FOR YOUR PLANNING PROFESSIONAL SUPPORT

TankClean

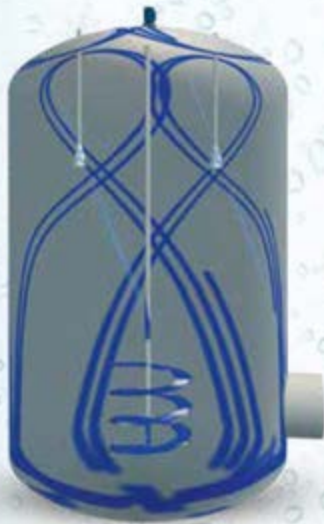

On the previous pages we provided you with the most important information for planning efficient tank and equipment cleaning. In many cases, this will already allow you to find the optimum solution for your requirements.

However, what if the situation is more complex? For example, due to fitting-related spray shadows – or if you want to be absolutely sure that every area in the tank has been fully cleaned? The solution here is simple: we will gladly support you with our TankClean simulation software.

With TankClean we can ...

- simulate tank geometries with a large number of fittings precisely and realistically
- select the right number of optimum nozzles and position them freely
- simulate the cleaning process and thus show spray shadows or other problematic areas
- record the simulation as a PDF and video

YOUR ADVANTAGES

PLANNING RELIABILITY

We assist you in planning your tank cleaning solution to ensure cleaning without any gaps.

PROCESS OPTIMIZATION

By simulating the existing cleaning processes, we show you the optimization potentials for these processes.

PROCESS RELIABILITY

Thanks to realistic and individually customizable process simulation, we can offer you individual solution concepts.

COST AND TIME SAVINGS

Simulation makes it possible to detect any potential problem areas before final definition of the cleaning concept. This makes it possible to significantly reduce the number of time- and cost-intensive practical cleaning tests.

See and understand TankClean



Discover the possibilities of TankClean: Visit www.lechler.com/de-en/tankclean or scan the QR code.



FOR YOUR PLANNING

CERTIFICATES AND DECLARATIONS

We can issue various certificates and declarations for our products. It must be checked in advance whether the desired document can be issued for a certain product. We will gladly inform you about the conditions for the documents on request.

Declaration of compliance EN 10204 - 2.1

This declaration confirms that the products have been manufactured and tested in accordance with the specifications.

Test report EN 10204 - 2.2

The report can be issued for the material (including the non-specific material certificate of the supplier), surface quality or spray parameters (spray angle and flow rate, without additional document).

Inspection certificate EN 10204 - 3.1

The inspection certificate is usually issued for the material. It can be issued for selected tank cleaning nozzles on request. In this case, production of the parts takes place on an order-specific basis with restamping.

However, a specific certificate can also be issued for the flow rate, spray angle nozzle dimensions, surface quality, etc.

FDA declaration of conformity

Confirmation that the material used complies with the specifications of the FDA.

3-A declaration of conformity

Confirmation that the product complies with the requirements of 3-A Sanitary Standards No. 78-03.

Declaration of conformity according to regulations (EC) No. 1935/2004 and (EC) No. 10/2011

Confirmation that the supplied product is suitable for use in contact with food and that the material complies with the above regulations.

ATEX type examination certificate

The ATEX type examination certificate certifies approval of the tank cleaning nozzle for corresponding ATEX environments.

Supplier declaration

Declaration on certificates of origin of the European Union, issued by Lechler. A supplier declaration can be issued for a specific order (individual supplier declaration) or as a long-term supplier declaration with a validity of two years.

Certificate of origin

Official confirmation of the origin of a product, certified by the Chamber of Commerce and Industry.

FOR YOUR PLANNING LECHLER ONLINE-SERVICES

3D design data

We can support you in your design work with the freely available 3D design data of Lechler nozzles and accessories.



After free registration, you can download the required data packages in all common CAD formats from www.lechler.com/de-en/service/cad.

- Time-saving, immediate download of 3D drawings and technical data
- Simple product selection like in Lechler print catalog
- Preview function with product photo and 3D graphics
- Available in all common 3D file formats

Ready at all times – the Lechler Industry app

The Lechler Industry app offers all important calculation and conversion functions in one place:

- Units converter for pressure, volume and flow rate
- Pressure/flow rate calculator for single fluid nozzles including axial-flow full cone nozzles
- Determination of the pipe diameter



iOS (Apple)



Android (Google)

Available free of charge in the Apple App Store and Google Play Store.

Current brochure



We are continuously developing our product range. You can always access the latest version of this brochure at www.lechler.com/de-en/catalogues.



Good to know

You can find current information about Lechler and our products and services online at www.lechler.com/de-en.





Cleaning efficiency class 1

Cleaning efficiency class 2

Cleaning efficiency class 3

Cleaning efficiency class 4

Cleaning efficiency class 5

Perfect add







FOR YOUR PLANNING OPTIMUM PREPARATION

Every industry and every process has its own requirements. We know them all and supply the optimum cleaning nozzles for an extremely wide range of ambient conditions.

FDA



FOOD CONFORMITY

Many of the materials used for Lechler tank cleaning nozzles comply with the requirements of the FDA and conform to the regulation EU1935/2004.



HYGIENE REQUIREMENTS

Lechler cleaning nozzles meet the strictest hygiene requirements. Selected series are available as specially certified 3-A-compliant nozzles.



ATEX

Lechler offers specially approved nozzle series for use in explosive atmospheres.



MAXIMUM OPERATING TEMPERATURE

Maximum permitted temperature of the cleaning medium during operation.



MAXIMUM AMBIENT TEMPERATURE

Maximum permitted ambient temperature within the tank.



INSTALLATION

The installation symbol describes the position in which the nozzle must be installed so that it functions properly.



BEARING

The primary bearing used is described here.



MATERIAL

Here you can find all materials that are used in the nozzle. This list permits a simple check of the chemical resistance.



WEIGHT

The weight is specified from the lightest to the heaviest nozzle within a series.



INSIDE AND
OUTSIDE

SURFACE QUALITY

We distinguish between surfaces inside the cleaning nozzle and outside surfaces. Excepted from this are threads, weld seams and gear wheels as well as areas in which the cleaning medium flows very quickly.



STEAM SUITABILITY

If the SIP process is realized by the cleaning nozzle, the suitability for hot water or even steam operation is decisive. Our products have been tested in vertically downwards-facing installation position at a temperature of 150 °C and a pressure of 2.5 bar(g) specifically for the extreme conditions in steam operation. The wear behavior differs depending on the design and materials used. We therefore categorize the steam suitability of our products as follows:

- Suitable (only slight wear evident after test duration of 50 h)
- Conditionally suitable (clear wear already evident after test duration of 25 h)
- Not suitable (the tested type was worn so that it was no longer capable of operation within a very short time)

It must be noted that operation with steam means increased wear irrespective of suitability. The following rule of thumb therefore applies: The lower the pressure, the lower the rotation speed and load and also the lower the wear of the cleaning nozzle.



INSERTION DIAMETER

This is the minimum diameter of the opening that is required to insert the cleaning nozzle in the tank. Since the exact insertion diameter depends on the selected type, a range is specified for some series. If the size of the insertion opening is within the specified range, the exact insertion diameter must be requested from Lechler.



RECOMMENDED OPERATING PRESSURE

The recommended operating pressure is the optimum pressure at which the nozzle cleans most efficiently. The recommended operating pressure must be determined directly in front of the nozzle.



ADAPTER

The HygienicFit adapter guarantees hygienic connection of the supply line. Compatible products are identified by this pictogram.



ROTATION MONITORING

These nozzles are compatible with the Lechler rotation monitoring sensor.



MAINTENANCE

All nozzles with the maintenance symbol can be maintained. You can find further information on pages 100–101.















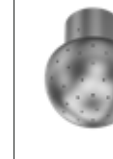









RECOMMENDED FILTER

We recommend a filter with the specified mesh size in order to prevent clogging and excessive wear of the cleaning nozzle.









Prüfstand 305

TANK CLEANING NOZZLES SERIES OVERVIEW



















		Cleaning efficiency class 1					
Series		Spray ball 527	Spray ball 540/541	RinseClean 5B2/5B3	PicoWhirly 500.234	MicroWhirly 566	MiniWhirly 500.186
Information on Page		30	32	34	40	42	44
							
	Operating principle						
	Max. tank diameter [m]	5.2–8.2	6.5–9.5	2.2–5.6	0.9	1.6–1.7	1.3
	Insertion diameter [mm]	35.0–102.0	31.0	20.0–90.0	9.0	20.0–48.0	29.0
	Recommended operating pressure [bar]	1.5	3.0	2.0	3.0	2.0	2.0
	Flow rate at recommended operating pressure [l/min]	52.0–364.0	22.0–145.0	15.0–1,000.0	9.8	15.0–21.0	18.0
	Food-compliant	●	●	●	●	●	
	ATEX available					●	
	Surface quality (outside) [µm]	≤ 0.8 µm	≤ 6.3 µm	≤ 0.8	≤ 1.6	≤ 1.6	≤ 1.6
	Steam suitability	suitable	suitable	suitable	suitable	suitable	not suitable
	Max. operating temperature [°C]	200	200	200	200	150	50
	Max. ambient temperature [°C]	250	250	250	200	200	100
	Compatible with HygienicFit						
	Rotation monitoring						
	Weight [g]	50–660	90–100	10–300	10	50–200	40
	Maintainable						









Cleaning efficiency class 2

PVDF MicroWhirly 500.191	NanoSpinner 2 5M1	MicroSpinner 2 5M2	MiniSpinner 2 5M3	MaxiSpinner 2 5M4	PTFE Whirly 573/583
46	48	50	52	56	58
					
					
0.8–1.1	1.4–1.6	1.7–1.8	1.8–2.6	4.0–5.0	2.4–3.2
30.0	17.0–34.0	28.0–48.0	39.0–58.0	69.0	49.0–78.4
2.0	2.0	2.0	2.0	2.0	2.0
13.0–20.0	15.0–20.0	23.0–40.0	30.0–100.0	135.0–250.0	58.0–225.0
●	●	●	●	●	●
	●	●	●	●	
≤ 1.6	≤ 0.4	≤ 0.4	≤ 0.4	≤ 0.4	≤ 0.8
not suitable	not suitable	conditionally suitable	conditionally suitable	conditionally suitable	not suitable
95	200	200	200	200	95
150	250	250	250	250	200
		●	●	●	
12–30	20	80–100	230–340	1,100–1,500	140–300





		Cleaning efficiency class 3		
Series		HygienicWhirly 594/595	Whirly 2 5W9	Gyro 577
Information on Page		64	66	68
				
	Operating principle			
	Max. tank diameter [m]	0.8–2.7	1.8–3.0	3.4–5.4
	Insertion diameter [mm]	31.5–48.0	69.5	110.0–156.0
	Recommended operating pressure [bar]	3.0	2.0	3.0
	Flow rate at recommended operating pressure [l/min]	14.0–82.0	48.0–145.0	200.0–659.0
	Food-compliant	●	●	●
	ATEX available		●	
	Surface quality (outside) [μm]	≤ 0.8	≤ 0.4	≤ 0.8
	Steam suitability	suitable	not suitable	conditionally suitable
	Max. operating temperature [°C]	150	150	95
	Max. ambient temperature [°C]	150	200	200
	Compatible with HygienicFit		●	
	Rotation monitoring			
	Weight [g]	90–290	360–500	640–1,920
	Maintainable			

Cleaning efficiency class 4		Cleaning efficiency class 5			
XactClean HP 2 5S6/5S7	XactClean HP+ 5S5	MeshClean 5T2/5T3	IntenseClean Hy- gienic 5TB	IntenseClean 5TM	PressureClean 5TP
72	76	80	82	84	86
					
					
3.5–8.0	9.0–9.6	11.5–13.0	14.0–15.0	18.0–24.0	1.0–3.5
50.0–79.0	81.0–140.0	68.0–82.0	130.0	160.0–230.0	65.0
3.0	3.0	5.0	5.0	5.0	100.0
40.0–213.0	202.0–367.0	20.0–79.0	169.0–238.0	198.0–411.0	10.0–30.0
●	●	●	●	●	
●		●	●	●	
≤ 1.6	≤ 0.8	≤ 0.8	≤ 0.8	≤ 0.8	≤ 1.6
suitable	suitable	suitable	suitable	not suitable	not suitable
150	150	150	150	95	90
150	150	150	150	140	50
●	●	●			
●	●	●	●	●	●
650–900	1,120–1,930	1,000	4,000	7,400–7,880	2,900–5,300
●	●	●	●	●	●



CLEANING EFFICIENCY CLASS 1 RINSE EFFICIENTLY AND RELIABLY

Type	Spray ball, static
Cleaning effect	
Drive	No drive, no rotating parts
Typical soiling	Light soiling such as non-adhering powder or liquids
Nozzle design	Static spray pattern with punctiform impact



Static spray balls Series 527

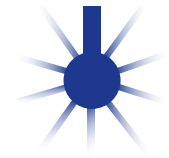

Features:

- Suitable for the highest hygiene requirements due to 3-A certification
- High surface quality
- Suitable for very high temperatures



Function video
www.lechler.com/de-en/medialibrary/videos-general-industry
 Or scan the QR code.

Series 527

Technical data:

Maximum operating temperature 200 °C	Maximum ambient temperature 250 °C	Installation Operation in every installation position	Bearing Static – no bearing
Material Stainless steel 1.4404 (316L)	Weight 50–660 g	Surface quality ≤ 0.8 µm <small>OUTSIDE</small>	Surface quality ≤ 0.8 µm <small>INSIDE</small>
Steam suitability Suitable	Insertion diameter 35–102 mm	Recommended filter Smaller than the narrowest cross-section	Recommended operating pressure 1.5 bar

Max. tank diameter
 The specified maximum tank diameter applies to the recommended operating pressure and is indicative only. The type of soiling is also decisive for the cleaning result.

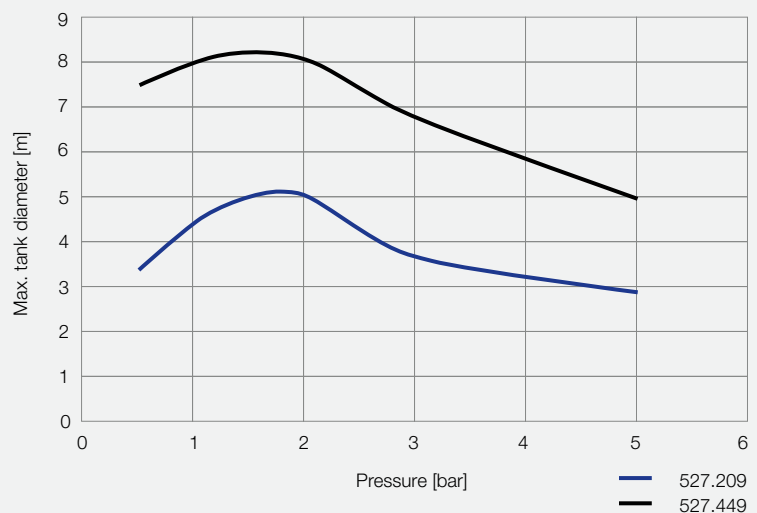

Overview of maximum tank diameter depending on pressure

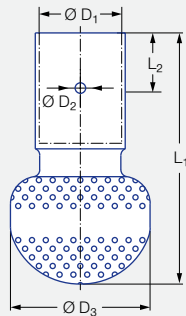

Dimensions of slip-on connection according to ASME-BPE (OD tube)

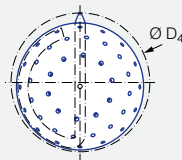

Insertion diameter D_4 of slip-on connection

With the slip-on connection, the spray ball is pushed onto the customer connecting pipe and secured with the supplied cotter pin.

Spray angle	Order no. Type	Narrowest cross-section \varnothing [mm]	\dot{V} water [l/min]				\dot{V} water		Dimensions [mm]						Max. tank diameter [m]
			p [bar] ($p_{max} = 5$ bar)				at 1.5 bar [m ³ /h]	at 2 bar [m ³ /h]	L_1	L_2	$\varnothing D_1$	$\varnothing D_2$	$\varnothing D_3$	$\varnothing D_4$	
			1.0	1.5	2.0	3.0									
 360°	527.209.1Y.00.75	0.8	42	52	60	73	3.1	3.6	68.0	12.7	19.0	3.3	32.0	35.0	5.2
	527.289.1Y.01.50	1.1	120	147	170	208	8.8	10.2	116.0	25.4	38.3	4.9	65.0	71.0	6.0
	527.449.1Y.02.00	1.7	297	364	420	514	21.8	25.2	152.0	25.4	51.0	4.9	102.0	102.0	8.2

Information on slip-on connection

- Cotter pin made of stainless steel 1.4404 (316L) included.
- Depending on the adapter diameter, the flow rate may increase due to the leakage between the adapter and spray ball.

Information on operation

Use above the recommended pressure will have a negative effect on the cleaning result and wear.

Static spray balls Series 540/541



Features:

- Robust and especially compact design
- Threaded connection
- Suitable for very high temperatures
- Also suitable for steam and air operation



Function video
www.lechler.com/de-en/medialibrary/videos-general-industry
 Or scan the QR code.

Series 540/541

Technical data:

Maximum operating temperature 200 °C	Maximum ambient temperature 250 °C	Installation Operation in every installation position	Bearing Static – no bearing
Material Stainless steel 1.4305 (303)	Weight 90–100 g	Surface quality √Ra ≤ 6.3 μm <small>OUTSIDE</small>	Surface quality √Ra ≤ 6.3 μm <small>INSIDE</small>
Steam suitability Suitable	Insertion diameter 31 mm	Recommended filter Smaller than the narrowest cross-section	Recommended operating pressure 3 bar

Max. tank diameter
 The specified maximum tank diameter applies to the recommended operating pressure and is indicative only. The type of soiling is also decisive for the cleaning result.

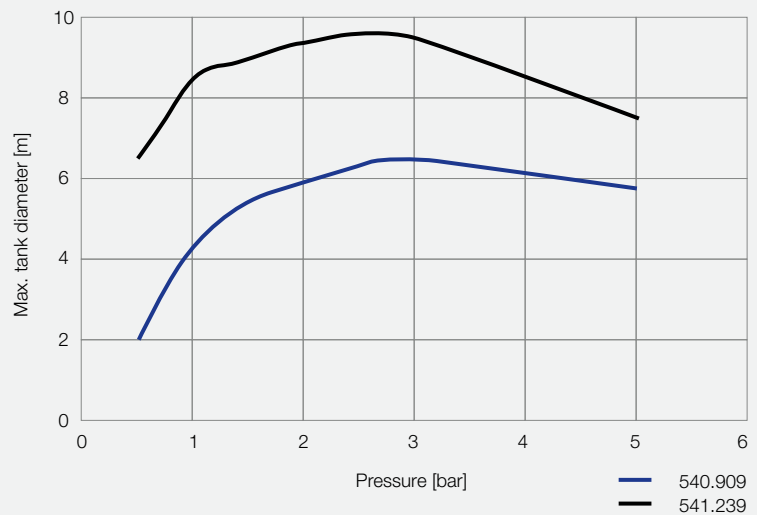

Overview of maximum tank diameter depending on pressure

Dimensions in mm.

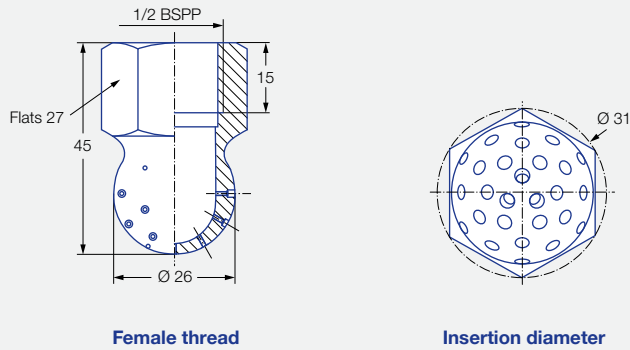

Female thread

Insertion diameter

Spray angle	Order no.	Narrowest cross-section \varnothing [mm]	\dot{V} water [l/min]					\dot{V} water	Max. tank diameter [m]
	Type		p [bar] ($p_{max} = 10$ bar)						
			0.5	1.0	2.0	3.0	5.0	at 3 bar [m ³ /h]	
240° 	540.909.16	0.8	9	13	18	22	28	1.3	6.5
	540.989.16	1.0	14	20	28	34	44	2.0	7.0
	541.109.16	1.5	29	40	57	70	90	4.2	7.5
	541.189.16	2.0	45	64	90	110	142	6.6	8.3
	541.239.16	2.3	59	83	118	145	187	8.7	9.5

NPT threads on request.

Information on operation

Use above the recommended pressure will have a negative effect on the cleaning result and wear.

Static spray balls RinseClean Series 5B2/5B3



Features:

- No moving parts
- Self-draining
- Proven in numerous applications
- Suitable for very high temperatures and high hygiene requirements
- Also available in 2.4602 (Alloy 22)



Function video
www.lechler.com/de-en/medialibrary/videos-general-industry
 Or scan the QR code.

Series 5B2/5B3

Technical data:

Maximum operating temperature 200 °C	Maximum ambient temperature 250 °C	Installation Operation in every installation position	Bearing Static – no bearing
Material Stainless steel 1.4404 (316L), cotter pin made of stainless steel 1.4404 (316L) or 2.4602 (Alloy 22), cotter pin made of 2.4602 (Alloy 22)	Weight 10–300 g	Surface quality Ra ≤ 0.8 µm OUTSIDE polished Ra ≤ 0.5 µm	Surface quality Ra ≤ 0.8 µm INSIDE
Steam suitability Suitable	Insertion diameter 20–90 mm	Recommended filter Smaller than the narrowest cross-section	Recommended operating pressure 2 bar

Max. tank diameter
 The specified maximum tank diameter applies to the recommended operating pressure and is indicative only. The type of soiling is also decisive for the cleaning result.

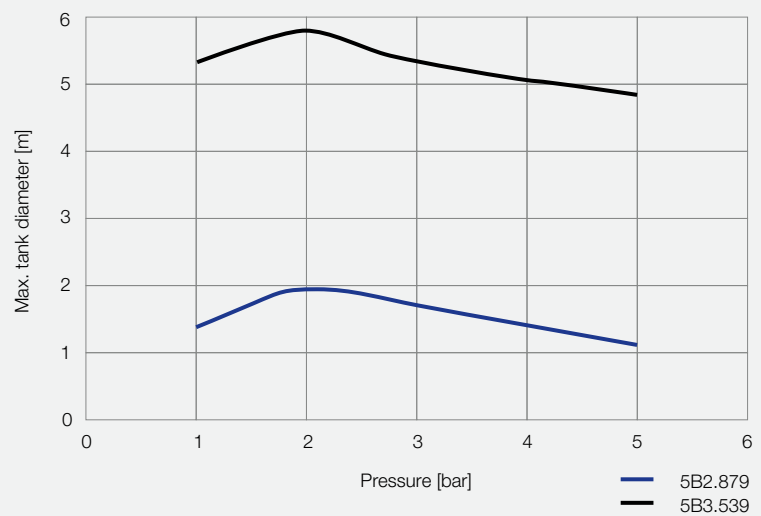

Overview of maximum tank diameter depending on pressure

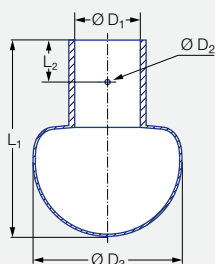

Pin 1

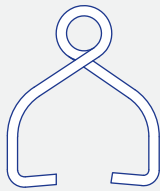

Pin 2-5

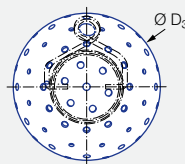
 Insertion diameter D_3
of slip-on connection

With the slip-on connection, the spray ball is pushed onto the customer connecting pipe and secured with the supplied cotter pin.

Slip-on connection according to DIN 10357, series B (replaces DIN 11850, series 1)

Spray angle	Order no.				Narrowest cross-section \varnothing [mm]	\dot{V} water [l/min]				\dot{V} water at 2 bar [m ³ /h]	Dimensions [mm]					Pin	Max. tank diameter [m]
	Type	Mat. no.		Connection		p [bar] ($p_{\max} = 5$ bar)					L_1	L_2	$\varnothing D_1$	$\varnothing D_2$	$\varnothing D_3$		
		1Y	21			0.5	1.0	2.0	3.0								
		1.4404 (316L)	2.4602 (Alloy 22)														
180°	5B3.083	●	●	D1.80	1.2	25	35	50	61	3.0	42.0	9.0	18.2	2.2	28.0	1	2.2
	5B3.253	●	●	D2.20	1.8	65	92	130	159	7.8	84.0	18.0	22.2	2.2	64.0	2	3.0
	5B3.323	●	●	D2.80	2.3	100	141	200	245	12.0	84.0	18.0	28.2	2.2	64.0	3	3.5
	5B3.463	●	●	D5.20	3.3	230	325	460	563	27.6	111.0	25.0	52.3	3.0	90.0	5	5.4
180°	5B3.114	●	●	D1.80	1.4	30	42	60	74	3.6	42.0	9.0	18.2	2.2	28.0	1	2.2
	5B3.274	●	●	D2.20	2.3	75	106	150	184	9.0	84.0	18.0	22.2	2.2	64.0	2	3.0
	5B3.394	●	●	D2.80	3.0	145	205	290	355	17.4	84.0	18.0	28.2	2.2	64.0	3	5.0
	5B3.444	●	●	D5.20	3.2	200	283	400	490	24.0	111.0	25.0	52.3	3.0	90.0	5	5.2
270°	5B3.305	●	●	D2.20	1.9	90	127	180	221	10.8	84.0	18.0	22.2	2.2	64.0	2	3.5
	5B3.345	●	●	D2.80	2.1	115	163	230	282	13.8	84.0	18.0	28.2	2.2	64.0	3	5.0
	5B3.385	●	●	D3.40	2.2	140	198	280	343	16.8	84.0	18.0	34.3	2.2	64.0	4	5.2
	5B3.405	●	●	D3.40	2.4	160	226	320	392	19.2	84.0	18.0	34.3	2.2	64.0	4	5.2
	5B3.425	●	●	D2.80	2.8	180	255	360	441	21.6	84.0	18.0	28.2	2.2	64.0	3	5.2
	5B3.445	●	●	D4.00	2.7	205	290	410	502	24.6	84.0	18.0	40.3	2.2	64.0	4	5.4
	5B3.475	●	●	D3.40	3.1	235	332	470	576	28.2	84.0	18.0	34.3	2.2	64.0	4	5.4
	5B3.535	●	●	D5.20	3.6	335	474	670	821	40.2	111.0	25.0	52.3	3.0	90.0	5	5.6
	5B3.605	●	●	D5.20	4.5	500	707	1,000	1,225	60.0	111.0	25.0	52.3	3.0	90.0	5	5.6
360°	5B2.879	●	●	D0.80	0.8	8	11	15	18	0.9	37.0	9.0	8.2	2.2	20.0	1	2.0
	5B3.089	●	●	D1.20	1.0	25	35	50	61	3.0	42.0	9.0	12.2	2.2	28.0	1	2.2
	5B3.139	●	●	D1.20	1.6	33	46	65	80	3.9	42.0	9.0	12.2	2.2	28.0	1	2.3
	5B3.209	●	●	D1.80	1.5	50	71	100	123	6.0	42.0	9.0	18.2	2.2	28.0	1	2.5
	5B3.309	●	●	D2.20	1.7	90	127	180	221	10.8	84.0	18.0	22.2	2.2	64.0	2	3.5
	5B3.379	●	●	D2.80	2.1	130	184	260	318	15.6	84.0	18.0	28.2	2.2	64.0	3	5.2
	5B3.389	●	●	D4.00	2.1	140	198	280	343	16.8	84.0	18.0	40.3	2.2	64.0	4	5.2
	5B3.409	●	●	D3.40	2.3	160	226	320	392	19.2	84.0	18.0	34.2	2.2	64.0	4	5.2
	5B3.449	●	●	D2.80	3.0	205	290	410	502	24.6	84.0	18.0	28.2	2.2	64.0	3	5.4
	5B3.489	●	●	D3.40	2.9	255	361	510	625	30.6	84.0	18.0	34.2	2.2	64.0	4	5.5
	5B3.499	●	●	D4.00	2.8	270	382	540	661	32.4	84.0	18.0	40.3	2.2	64.0	4	5.5
	5B3.539	●	●	D5.20	3.2	335	474	670	821	40.2	111.0	25.0	52.3	3.0	90.0	5	5.6

Pin	Order no.	
	1Y	21
	Stainless steel 1.4404 (316L)	2.4602 (Alloy 22)
1	095.013.1Y.06.55	095.013.21.06.55
2	095.013.1Y.06.58	095.013.21.06.58
3	095.013.1Y.06.56	095.013.21.06.56
4	095.013.1Y.06.59	095.013.21.06.59
5	095.013.1Y.06.57	

Note

Available in polished version on request.

Information on slip-on connection

- Cotter pin made of stainless steel 1.4404 (316L) or 2.4602 (Alloy 22) included.
- Depending on the adapter diameter, the flow rate may increase due to the leakage between the adapter and spray ball.

Information on operation

Use above the recommended pressure will have a negative effect on the cleaning result and wear.

Ordering Type + Material no. + Connection = Order no.
example: 5B3.083 + 1Y + D1.80 = 5B3.083.1Y.D1.80



Slip-on connection

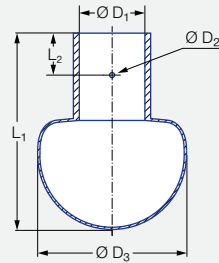

Pin 1

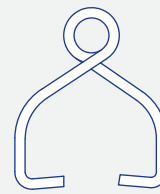

Pin 2-5

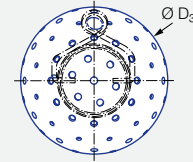

Insertion diameter D_3 of slip-on connection

Slip-on connection according to DIN EN 10357 series A (replaces DIN 11850, series 2)

Spray angle	Order no.				Narrowest cross-section \varnothing [mm]	\dot{V} water [l/min]				\dot{V} water at 2 bar [m ³ /h]	Dimensions [mm]					Pin	Max. tank diameter [m]
	Type	Mat. no.		Connection		p [bar] ($p_{max} = 5$ bar)					L_1	L_2	$\varnothing D_1$	$\varnothing D_2$	$\varnothing D_3$		
		1Y	21			0.5	1.0	2.0	3.0								
		1.4404 (316L)	2.4602 (Alloy 22)														
360° 	5B3.149	●	●	D2.90	0.9	35	50	70	86	4.2	84.0	18.0	29.2	2.2	64.0	3	2.3
	5B3.299	●	●	D2.90	1.5	83	117	165	202	9.9	84.0	18.0	29.2	2.2	64.0	3	3.2
	5B3.359	●	●	D2.90	1.9	115	163	230	282	13.8	84.0	18.0	29.2	2.2	64.0	3	5.0
	5B3.399	●	●	D2.90	2.2	150	212	300	367	18.0	84.0	18.0	29.2	2.2	64.0	3	5.2
	5B3.429	●	●	D2.90	2.6	180	255	360	441	21.6	84.0	18.0	29.2	2.2	64.0	3	5.2
	5B3.539	●	●	D5.30	3.2	335	474	670	821	40.2	111.0	25.0	53.3	3.0	90.0	5	5.6

Slip-on connection according to DIN EN 10357 series D (ASME BPE 1997, OD-tube compatible)

Spray angle	Order no.				Narrowest cross-section \varnothing [mm]	\dot{V} water [l/min]				\dot{V} water at 2 bar [m ³ /h]	Dimensions [mm]					Pin	Max. tank diameter [m]
	Type	Mat. no.		Connection		p [bar] ($p_{max} = 5$ bar)					L_1	L_2	$\varnothing D_1$	$\varnothing D_2$	$\varnothing D_3$		
		1Y	21			0.5	1.0	2.0	3.0								
		1.4404 (316L)	2.4602 (Alloy 22)														
360° 	5B3.089	●	●	A1.00	1.0	25	35	50	61	3.0	42.0	9.0	9.8	2.2	28.0	1	2.2
	5B3.209	●	●	A1.90	1.5	50	71	100	123	6.0	42.0	9.0	19.3	2.2	28.0	1	2.5
	5B3.309	●	●	A1.90	1.7	90	127	180	221	10.8	84.0	18.0	19.3	2.2	64.0	1	3.5
	5B3.379	●	●	A2.60	2.1	130	184	260	318	15.6	84.0	18.0	25.6	2.2	64.0	3	5.2
	5B3.449	●	●	A3.80	3.0	205	290	410	502	24.6	84.0	18.0	38.3	2.2	64.0	4	5.4
	5B3.539	●	●	A5.10	3.2	335	474	670	821	40.2	111.0	25.0	51.1	3.0	90.0	5	5.6

Information on slip-on connection

- Cotter pin made of stainless steel 1.4404 (316L) or 2.4602 (Alloy 22) included.
- Depending on the adapter diameter, the flow rate may increase due to the leakage between the adapter and spray ball.

Threaded connection

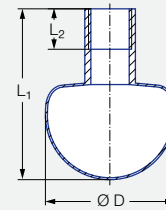

Threaded connection

Spray angle	Order no.							Narrowest cross-section Ø [mm]	V̇ water [l/min]				V̇ water at 2 bar [m³/h]	Dimensions [mm]			Max. tank diameter [m]
	Type	Mat. no.		Connection					p [bar] (p _{max} = 5 bar)					L ₁	L ₂	Ø D	
		1Y	21	1/8 BSPP male	1/2 BSPP	1 BSPP	2 BSPP		0.5	1.0	2.0	3.0					
		1.4404 (316L)	2.4602 (Alloy 22)														
360° 	5B2.879	●	●	AA				0.8	8	11	15	18	0.9	37	8	20	2.0
	5B3.309	●	●		AH			1.9	90	127	180	221	10.8	84	14	64	3.5
	5B3.379	●	●				AN	2.1	130	184	260	318	15.6	84	18	64	5.2
	5B3.539	●					AW	3.1	335	474	670	821	40.2	111	24	90	5.6

Welded connection

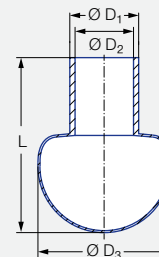

Welded connection according to ISO 2037

Spray angle	Order no.				Narrowest cross-section Ø [mm]	V̇ water [l/min]				V̇ water at 2 bar [m³/h]	Dimensions [mm]				Max. tank diameter [m]
	Type	Mat. no.		Connection		p [bar] (p _{max} = 5 bar)					Adapter				
		1Y	21			0.5	1.0	2.0	3.0		L	Ø D ₁	Ø D ₂	Ø D ₃	
		1.4404 (316L)	2.4602 (Alloy 22)												
360° 	5B2.879	●	●	W1.20	0.8	8	11	15	18	0.9	37.0	12.0	10.0	20.0	2.0
	5B3.089	●	●	W1.20	1.0	25	35	50	61	3.0	42.0	12.0	10.0	28.0	2.2
	5B3.209	●	●	W1.70	1.5	50	71	100	123	6.0	42.0	17.2	15.2	28.0	2.5
	5B3.309	●	●	W2.50	1.7	90	127	180	221	10.8	84.0	25.0	22.6	64.0	3.5
	5B3.379	●	●	W2.50	2.1	130	184	260	318	15.6	84.0	25.0	22.6	64.0	5.2
	5B3.449	●	●	W3.80	3.0	205	290	410	502	24.6	84.0	38.0	35.6	64.0	5.4

Information on operation

Use above the recommended pressure will have a negative effect on the cleaning result and wear.



CLEANING EFFICIENCY CLASS 2 RINSING AND LIGHT CLEANING

Type	Rotating cleaner, free-spinning
Cleaning effect	
Drive	By the medium
Typical soiling	Low-viscosity to slightly viscous substances such as fresh ketchup
Nozzle design	Slot design or bore layout with direct impact on the entire tank surface



Rotating cleaning nozzle PicoWhirly Series 500.234



Features:

- Cleaning with rotating solid jets
- Compact design for confined spaces
- Suitable for very high temperatures
- Made completely of stainless steel



Function video
www.lechler.com/de-en/medialibrary/videos-general-industry
 Or scan the QR code.

Series 500.234

Technical data:



Maximum operating temperature
200 °C



Maximum ambient temperature
200 °C



Installation
Operation in every installation position



Bearing
Kolsterised slide bearing



Material
Stainless steel 1.4404 (316L)



Weight
10 g



Surface quality
Ra ≤ 1.6 µm



Surface quality
Ra ≤ 1.6 µm



Steam suitability
Suitable



Insertion diameter
9 mm



Recommended filter
Line strainer with a mesh size of 0.3 mm/50 mesh



Recommended operating pressure
3 bar



Max. tank diameter

The specified maximum tank diameter applies to the recommended operating pressure and is indicative only. The type of soiling is also decisive for the cleaning result.

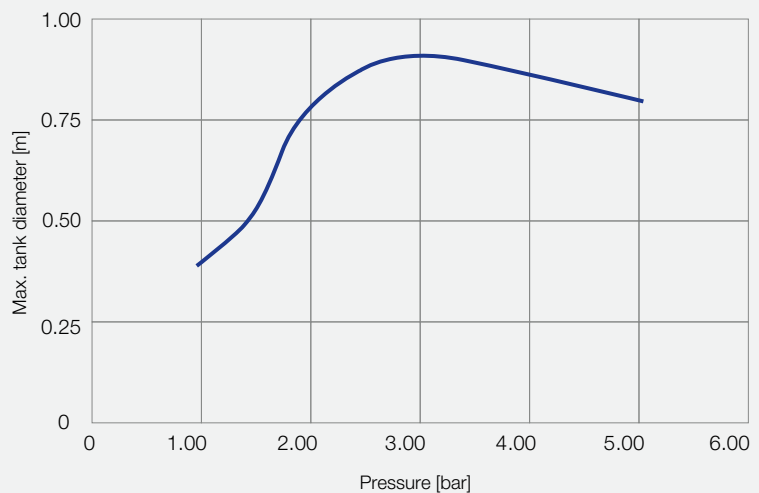

Overview of maximum tank diameter depending on pressure

Dimensions in mm.

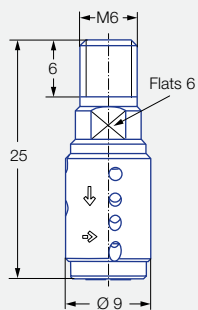

Male thread

Spray angle	Order no.	Narrowest cross-section \varnothing [mm]	\dot{V} water [l/min]				\dot{V} water	Max. tank diameter [m]
	Type		p [bar] ($p_{max} = 5$ bar)					
			1.0	2.0	3.0	5.0	at 3 bar [m ³ /h]	
300° 	500.234.G9.00	1.8	5.7	8.0	9.8	12.7	0.6	0.9

Information on operation

Compressed air can be used only for a short time for blowing dry. Use above the recommended pressure will have a negative effect on the cleaning result and wear.

Rotating cleaning nozzle MicroWhirly Series 566



Features:

- Cleaning with effective flat fan jets
- Robust slide bearing made of PEEK
- Connection via thread or slip-on connection



Function video
www.lechler.com/de-en/medialibrary/videos-general-industry
 Or scan the QR code.

Series 566

Technical data:

Maximum operating temperature 150 °C 90 °C (ATEX)	Maximum ambient temperature 200 °C 120 °C (ATEX)	Installation Operation in every installation position	Bearing Slide bearing made of PEEK
Material Stainless steel 1.4404 (316L), PEEK ESD (only ATEX version)	Weight 50–200 g	Surface quality Ra ≤ 1.6 µm <small>OUTSIDE</small>	Surface quality Ra ≤ 1.6 µm <small>INSIDE</small>
Steam suitability Suitable	Insertion diameter 20–48 mm	Recommended filter Line strainer with a mesh size of 0.3 mm/50 mesh	Recommended operating pressure 2 bar

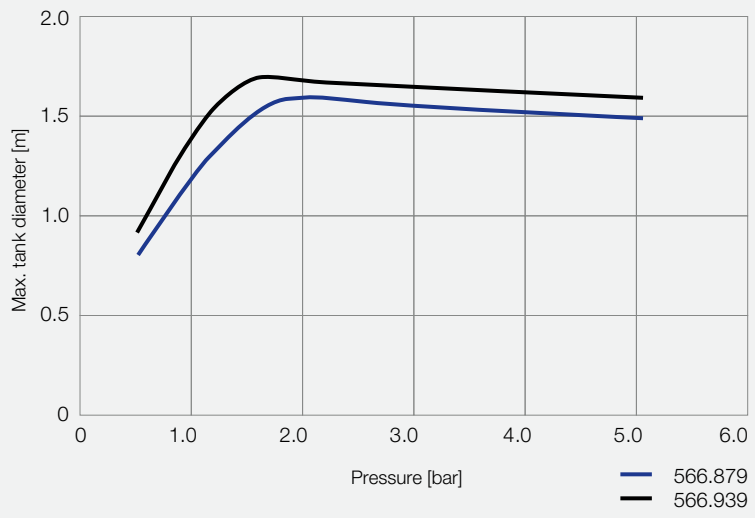

Max. tank diameter
 The specified maximum tank diameter applies to the recommended operating pressure and is indicative only. The type of soiling is also decisive for the cleaning result.

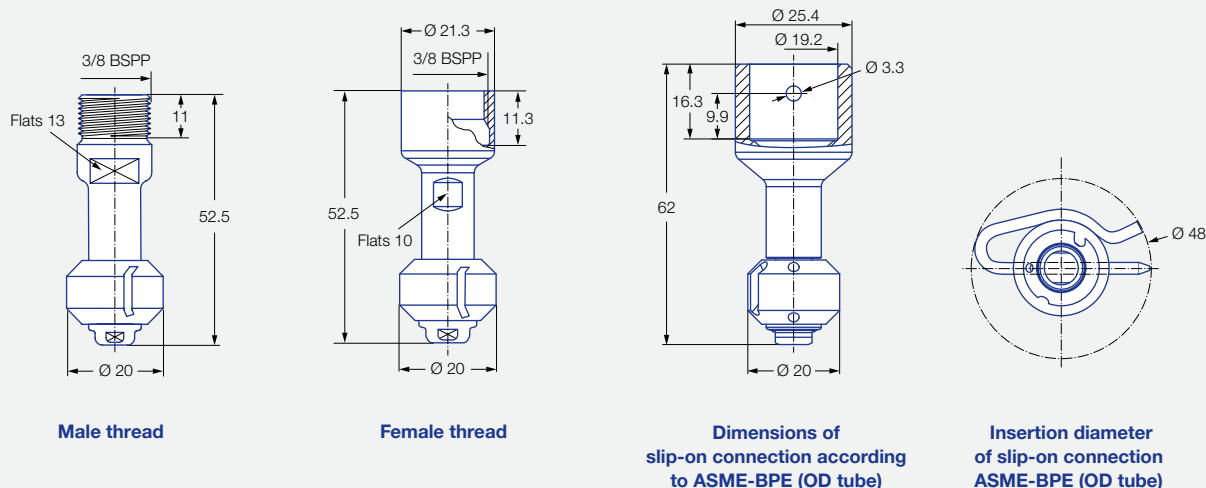

Overview of maximum tank diameter depending on pressure

Dimensions in mm.



Spray angle	Order no.				Narrowest cross-section \varnothing [mm]	\dot{V} water [l/min]			\dot{V} water at 2 bar [m ³ /h]	Max. tank diameter [m]
	Type	Connection				p [bar] (p _{max} = 6 bar)				
		3/8 BSPP male	3/8 BSPP female	3/4" slip-on connection		1.0	2.0	3.0		
180° 	566.873.1Y	AE	AF	TF07	1.0	12	15	18	0.9	1.6
	566.933.1Y	AE	AF	TF07	2.4	15	21	26	1.3	1.7
180° 	566.874.1Y	AE	AF	TF07	1.0	12	15	18	0.9	1.6
	566.934.1Y	AE	AF	TF07	2.4	15	21	26	1.3	1.7
360° 	566.879.1Y	AE	AF	TF07	1.0	12	15	18	0.9	1.6
	566.939.1Y	AE	AF	TF07	2.4	15	21	26	1.3	1.7

NPT threads and weld-on version on request.

Information on operation

Compressed air can be used only for a short time for blowing dry. Use above the recommended pressure will have a negative effect on the cleaning result and wear.

Information on slip-on connection

- Cotter pin made of stainless steel 1.4404 (316L) included.
- Depending on the adapter diameter, the flow rate may increase due to the leakage between the adapter and rotating cleaning nozzle.

Ordering example with FDA and (EC) 1935/2004 conformity.

All materials are suitable for contact with food.



Type + Connection = Order no.
566.873.1Y + AE = 566.873.1Y.AE

Ordering example with ATEX approval. No FDA and (EC) 1935/2004 conformity.

Unit group/Category/Zones:

- Ex II 1G Ex h IIB T6...T3 Ga
- Ex II 1D Ex h IIIC T85 °C...T150 °C Da



Important

The code for the connection changes for the ATEX version with slip-on connection. Ordering example for slip-on connection: 566.873.1Y.TF.EX

Type + Connection + ATEX = Order no.
566.873.1Y + AE + EX = 566.873.1Y.AE.EX

Rotating cleaning nozzle MiniWhirly Series 500.186



Features:













- Economical entry-level model
- Cleaning with effective flat fan jets
- Specially designed for barrel and canister cleaning



Function video
www.lechler.com/de-en/medialibrary/videos-general-industry
 Or scan the QR code.

Series 500.186

Technical data:

 Maximum operating temperature 50 °C	 Maximum ambient temperature 100 °C	 Installation Vertically downwards	 Bearing Ball bearing made of stainless steel 1.4401 (316)
 Material POM, stainless steel 1.4401 (316)	 Weight 40 g	 Surface quality Ra ≤ 1.6 µm	 Surface quality Ra ≤ 1.6 µm
 Steam suitability Not suitable	 Insertion diameter 29 mm	 Recommended filter Line strainer with a mesh size of 0.3 mm/50 mesh	 Recommended operating pressure 2 bar

 **Max. tank diameter**
 The specified maximum tank diameter applies to the recommended operating pressure and is indicative only. The type of soiling is also decisive for the cleaning result.

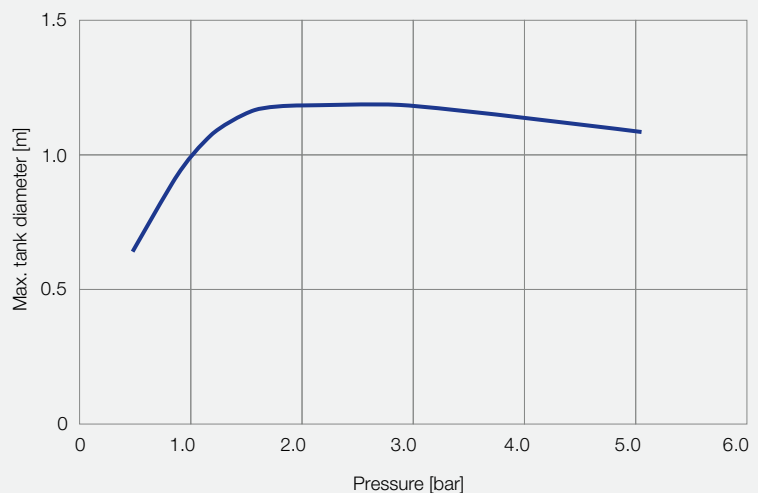

Overview of maximum tank diameter depending on pressure

Dimensions in mm.

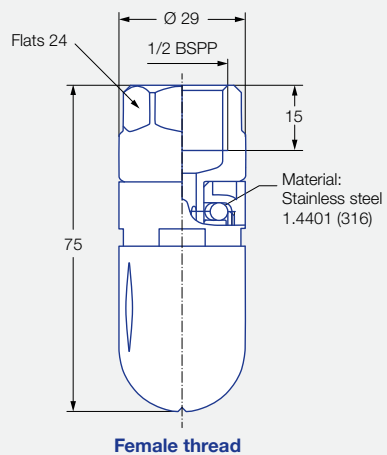

Spray angle	Order no.	Narrowest cross-section \varnothing [mm]	\dot{V} water [l/min]			\dot{V} water	Max. tank diameter [m]
	Type		p [bar] ($p_{\max} = 5$ bar)				
			1.0	2.0	3.0	at 2 bar [m ³ /h]	
300° 	500.186.56.AH	1.9	13	18	22	1.1	1.3

Information on operation

Compressed air can be used only for a short time for blowing dry. Use above the recommended pressure will have a negative effect on the cleaning result and wear.

Rotating cleaning nozzle PVDF MicroWhirly Series 500.191



Features:













- Developed for work in corrosive environments
- Good suitability for food contact and foam delivery
- Made completely of PVDF



Function video
www.lechler.com/de-en/medialibrary/videos-general-industry
 Or scan the QR code.

Series 500.191

Technical data:

 Maximum operating temperature 95 °C	 Maximum ambient temperature 150 °C	 Installation Operation in every installation position	 Bearing Slide bearing made of PVDF
 Material PVDF	 Weight 12–30 g	 Surface quality Ra ≤ 1.6 µm	 Surface quality Ra ≤ 1.6 µm
 Steam suitability Not suitable	 Insertion diameter 30 mm	 Recommended filter Line strainer with a mesh size of 0.3 mm/50 mesh	 Recommended operating pressure 2 bar

 **Max. tank diameter**
 The specified maximum tank diameter applies to the recommended operating pressure and is indicative only. The type of soiling is also decisive for the cleaning result.

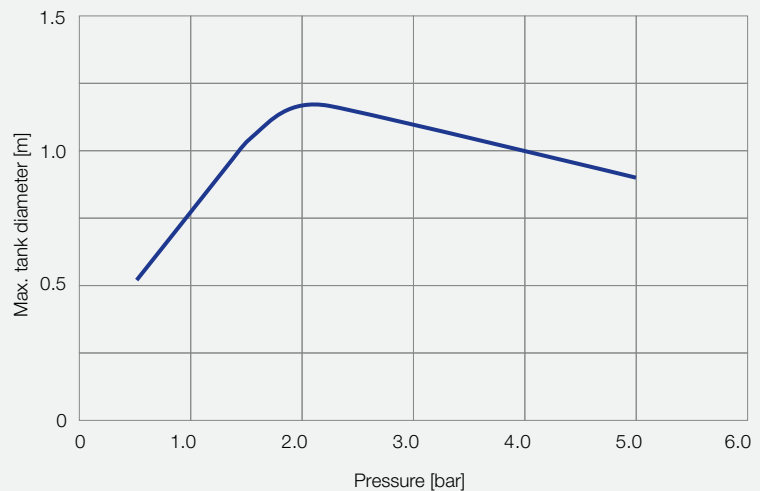

Overview of maximum tank diameter depending on pressure

Dimensions in mm.

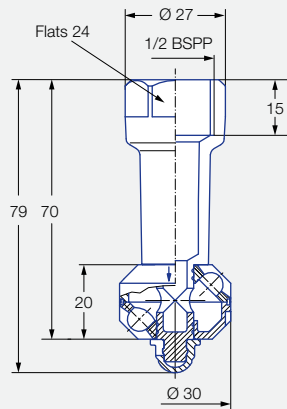



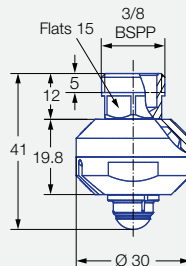

Standard version
Female thread





Compact version
Male thread

Standard version with female thread

Spray angle	Order no.	Narrowest cross-section Ø [mm]	V̇ water [l/min]			V̇ water at 2 bar [m³/h]	Max. tank diameter [m]
	Type		p [bar] (p _{max} = 5 bar)				
			1.0	2.0	3.0		
180° 	500.191.5E.02	2.2	9	13	16	0.8	0.8
180° 	500.191.5E.01	2.2	9	13	16	0.8	0.8
270° 	500.191.5E.31	2.2	14	20	25	1.2	1.1
360° 	500.191.5E.00	2.2	14	20	25	1.2	1.1

Compact version with male thread

Spray angle	Order no.	Narrowest cross-section Ø [mm]	V̇ water [l/min]			V̇ water at 2 bar [m³/h]	Max. tank diameter [m]
	Type		p [bar] (p _{max} = 5 bar)				
			1.0	2.0	3.0		
180° 	500.191.5E.21	2.2	9	13	16	0.8	0.8
360° 	500.191.5E.22	2.2	14	20	25	1.2	1.1

Information on operation

The PVDF MicroWhirly is not suitable for operation with compressed air or another gas. Use above the recommended pressure will have a negative effect on the cleaning result and wear.

Rotating cleaning nozzle NanoSpinner 2 Series 5M1



Features:

- Compact design for confined spaces
- Hygienic design
- Suitable for high temperatures
- Completely made of stainless steel 1.4404 (316L) or 2.4602 (Alloy 22)



Function video
www.lechler.com/de-en/medialibrary/videos-general-industry
 Or scan the QR code.

Series 5M1

Technical data:



Maximum operating temperature
 200 °C
 95 °C (ATEX)



Maximum ambient temperature
 250 °C
 200 °C (ATEX)



Installation
 Operation in every installation position



Bearing
 Double ball bearing made of stainless steel 1.4404 (316L) or 2.4602 (Alloy 22)



Material
 Stainless steel 1.4404 (316L) or 2.4602 (Alloy 22)



Weight
 20 g



Surface quality
 $Ra \leq 0.4 \mu m$



Surface quality
 $Ra \leq 0.8 \mu m$



Steam suitability
 Not suitable



Insertion diameter
 17–34 mm



Recommended filter
 Line strainer with a mesh size of 0.1 mm/170 mesh



Recommended operating pressure
 2 bar



Max. tank diameter
 The specified maximum tank diameter applies to the recommended operating pressure and is indicative only. The type of soiling is also decisive for the cleaning result.

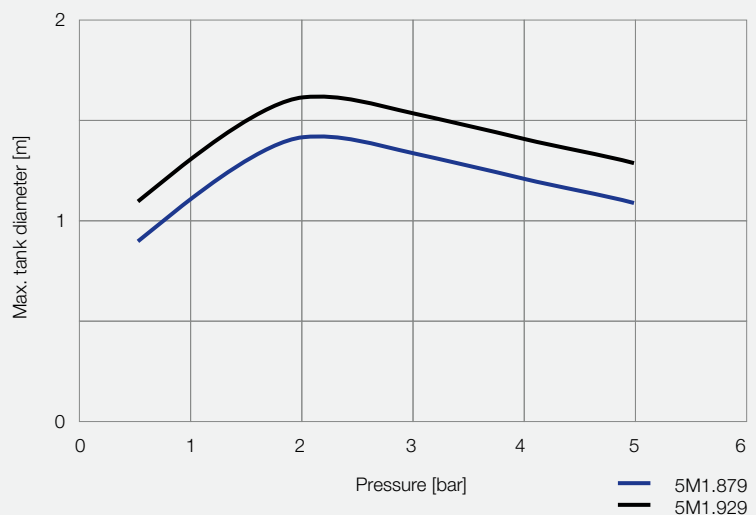

Overview of maximum tank diameter depending on pressure

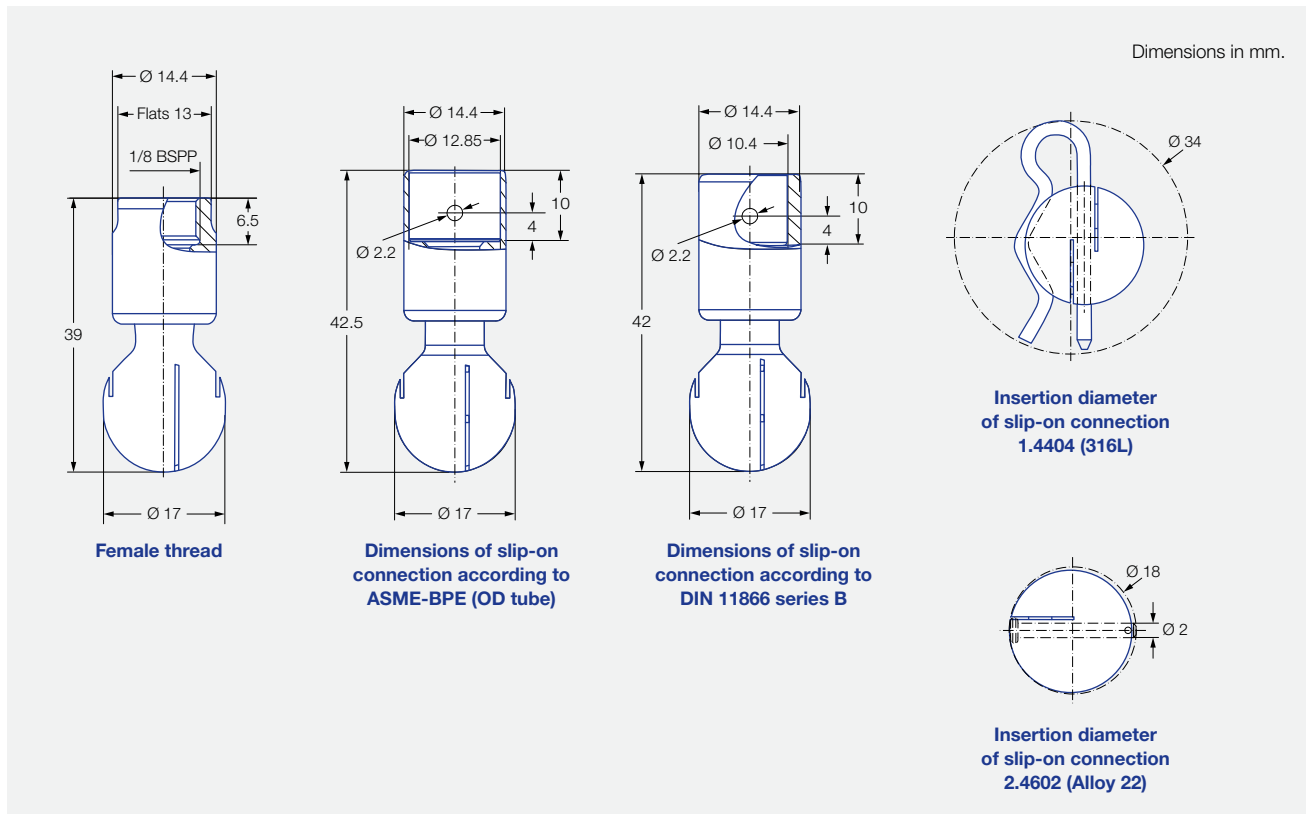

Spray angle	Order no.						Narrowest cross-section \varnothing [mm]	V water [l/min]			V water at 2 bar [m ³ /h]	Max. tank diameter [m]
	Type	Mat. no.		Connection				p [bar] (p _{max} = 7 bar)				
		1Y	21	1/8 BSPP	$\varnothing 10.2$ mm in accordance with DIN 11866 Series B	1/2" slip-on connection		1.0	2.0	3.0		
360° 	5M1.879	●	●	AB	TF04	TF05 ¹	0.4	11	15	18	0.9	1.4
	5M1.929	●	●	AB	TF04	TF05 ¹	0.5	14	20	25	1.2	1.6

¹ The connection variant TF05 is not available as an ATEX variant.

NPT threads and weld-on version on request.

Information on operation

Compressed air can be used only for a short time for blowing dry. Use above the recommended pressure will have a negative effect on the cleaning result and wear.

Information on slip-on connection

- Cotter pin made of stainless steel 1.4404 (316L) included (Order no. 05M.130.1Y.00.00). For version made of 2.4602 (Alloy 22), bolt with head incl. cotter pin included (Order no. 05M.131.21.00.00).
- Depending on the adapter diameter, the flow rate may increase due to the leakage between the adapter and rotating cleaning nozzle.

Ordering example with FDA and (EC) 1935/2004 conformity.

All materials are suitable for contact with food.



Type + Material no. + Connection = Order no.
5M1.879 + 1Y + AB = 5M1.879.1Y.AB

Ordering example with ATEX approval, FDA and (EC) 1935/2004 conformity.

Unit group/Category/Zones:

- ⊕ II 1G Ex h IIB T6...T2 Ga
- ⊕ II 1D Ex h IIC T85 °C...T250 °C Da



Important

The code for the connection changes for the ATEX version with slip-on connection.
Ordering example for slip-on connection: 5M1.879.1Y.T0.EX



Type + Material no. + Connection + ATEX = Order no.
5M1.879 + 1Y + AB + EX = 5M1.879.1Y.AB.EX

Rotating cleaning nozzle MicroSpinner 2 Series 5M2



Features:

- Hygienic design
- Suitable for high temperatures
- Completely made of stainless steel 1.4404 (316L) or 2.4602 (Alloy 22)



Function video
www.lechler.com/de-en/medialibrary/videos-general-industry
 Or scan the QR code.

Series 5M2

Technical data:



Maximum operating temperature
 200 °C
 95 °C (ATEX)



Maximum ambient temperature
 250 °C
 200 °C (ATEX)



Installation
 Operation in every installation position



Bearing
 Double ball bearing made of stainless steel 1.4404 (316L) or 2.4602 (Alloy 22)



Material
 Stainless steel 1.4404 (316L) or 2.4602 (Alloy 22)



Weight
 80–100 g



Surface quality
 $Ra \leq 0.4 \mu m$



Surface quality
 $Ra \leq 0.8 \mu m$



Steam suitability
 Conditionally suitable



Insertion diameter
 28–48 mm



Recommended filter
 Line strainer with a mesh size of 0.1 mm/170 mesh



Recommended operating pressure
 2 bar



Adapter
 3/8 BSPP is compatible with HygienicFit



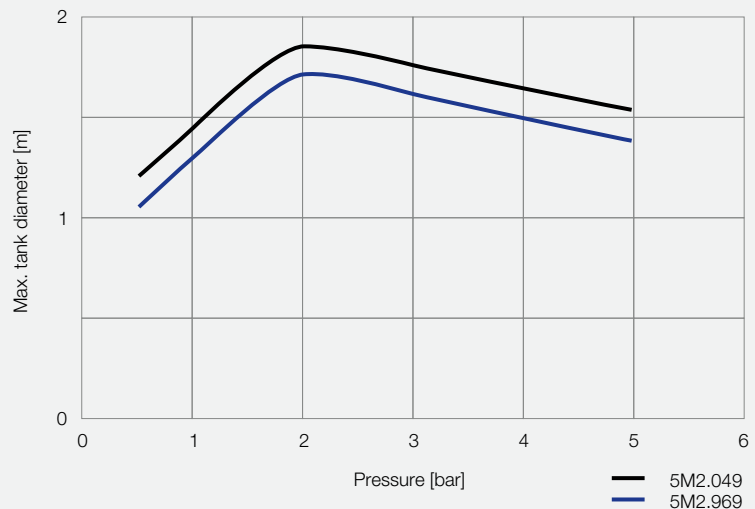

Max. tank diameter
 The specified maximum tank diameter applies to the recommended operating pressure and is indicative only. The type of soiling is also decisive for the cleaning result.

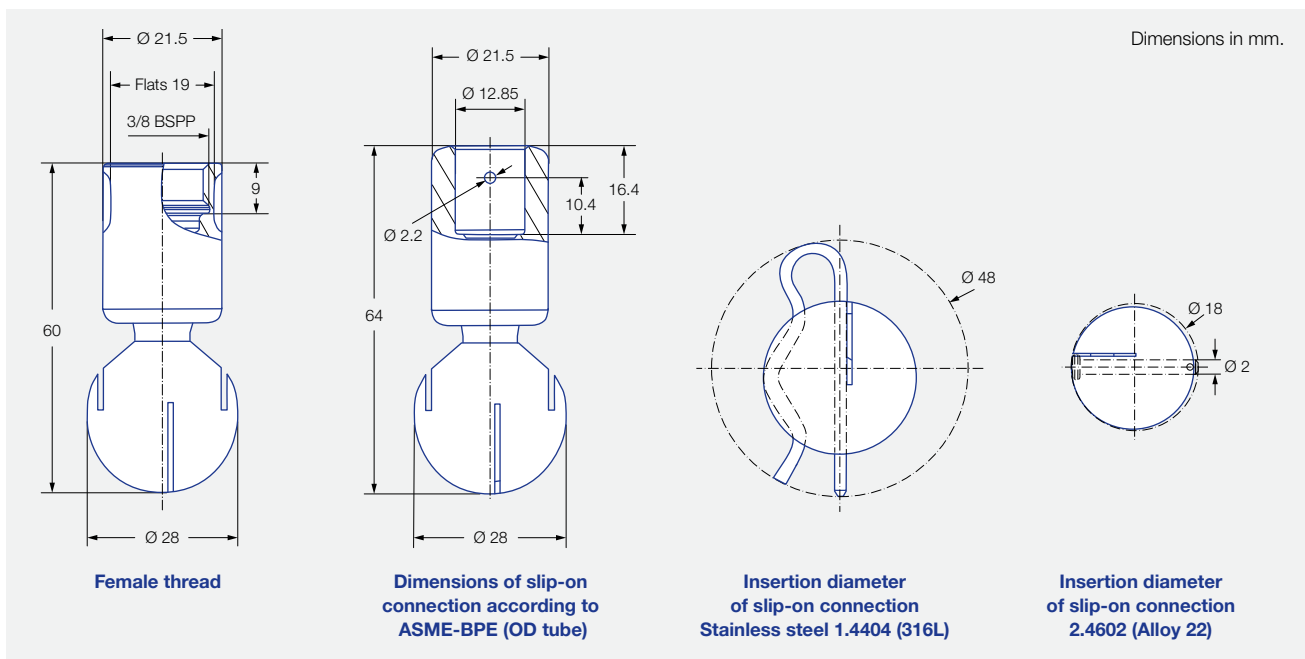

Overview of maximum tank diameter depending on pressure



Spray angle	Order no.					Narrowest cross-section \varnothing [mm]	\dot{V} water [l/min]			\dot{V} water at 2 bar [m ³ /h]	Max. tank diameter [m]
	Type	Mat. no.		Connection			p [bar] (p _{max} = 7 bar)				
		1Y	21	3/8 BSPP	1/2" slip-on connection		1.0	2.0	3.0		
60° 	5M2.952	●	●	AF	TF05	1.5	16	23	28	1.4	–
	5M2.042	●	●	AF	TF05	3.0	28	40	49	2.4	–
180° 	5M2.004	●	●	AF	TF05	0.9	22	32	39	1.9	1.8
360° 	5M2.969	●	●	AF	TF05	0.8	18	25	31	1.5	1.7
	5M2.049	●	●	AF	TF05	0.9	28	39	48	2.3	1.8

NPT threads, other slip-on connections and weld-on versions on request.

Information on operation

Compressed air can be used only for a short time for blowing dry. Use above the recommended pressure will have a negative effect on the cleaning result and wear.

Information on slip-on connection

- Cotter pin made of stainless steel 1.4404 (316L) included (Order no. 05M.230.1Y.00.00). For version made of 2.4602 (Alloy 22), bolt with head incl. cotter pin included (Order no. 05M.231.21.00.00).
- Depending on the adapter diameter, the flow rate may increase due to the leakage between the adapter and rotating cleaning nozzle.

Ordering example with FDA and (EC) 1935/2004 conformity.

All materials are suitable for contact with food.



Type + Material no. + Connection = Order no.
5M2.952 + 1Y + AF = 5M2.952.1Y.AF

Ordering example with ATEX approval, FDA and (EC) 1935/2004 conformity.

Unit group/Category/Zones:

- Ex II 1G Ex h IIB T6...T2 Ga
- Ex II 1D Ex h IIIC T85 °C...T250 °C Da



Important

The code for the connection changes for the ATEX version with slip-on connection.
Ordering example for slip-on connection: 5M2.952.1Y.T1.EX



Type + Material no. + Connection + ATEX = Order no.
5M2.952 + 1Y + AF + EX = 5M2.952.1Y.AF.EX

Rotating cleaning nozzle MiniSpinner 2 Series 5M3



Features:

- Hygienic design
- Suitable for high temperatures
- Completely made of stainless steel 1.4404 (316L) or 2.4602 (Alloy 22)



Function video
www.lechler.com/de-en/medialibrary/videos-general-industry
 Or scan the QR code.

Series 5M3

Technical data:



Maximum operating temperature
 200 °C
 95 °C (ATEX)



Maximum ambient temperature
 250 °C
 200 °C (ATEX)



Installation
 Operation in every installation position



Bearing
 Double ball bearing made of stainless steel 1.4404 (316L) or 2.4602 (Alloy 22)



Material
 Stainless steel 1.4404 (316L) or 2.4602 (Alloy 22)



Weight
 230–340 g



Surface quality
 $Ra \leq 0.4 \mu m$
OUTSIDE



Surface quality
 $Ra \leq 0.8 \mu m$
INSIDE



Steam suitability
 Conditionally suitable



Insertion diameter
 39–58 mm



Recommended filter
 Line strainer with a mesh size of 0.1 mm/170 mesh



Recommended operating pressure
 2 bar



Adapter
 1/2 BSPP and 3/4 BSPP are compatible with HygienicFit



Max. tank diameter
 The specified maximum tank diameter applies to the recommended operating pressure and is indicative only. The type of soiling is also decisive for the cleaning result.

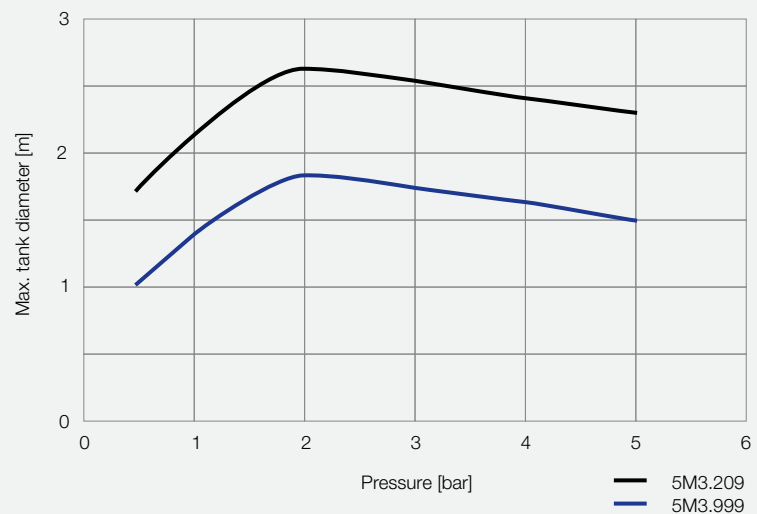

Overview of maximum tank diameter depending on pressure

Dimensions in mm.

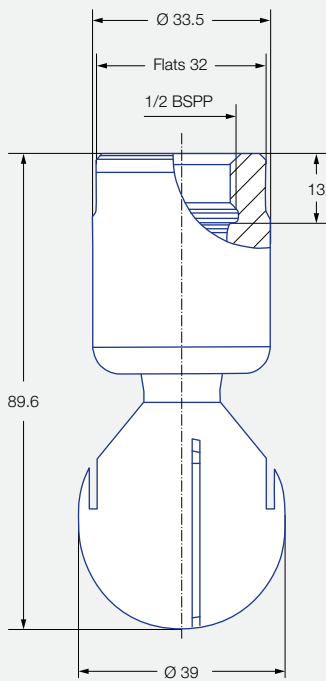

Female thread

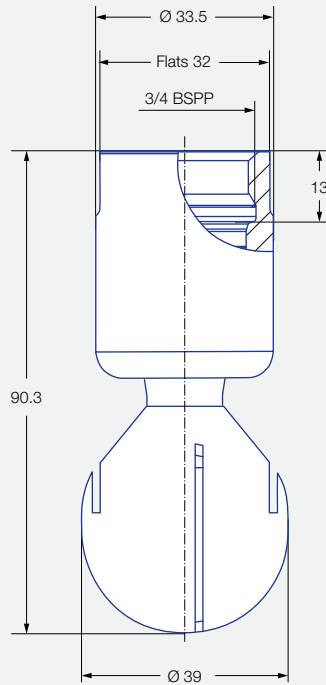

Female thread

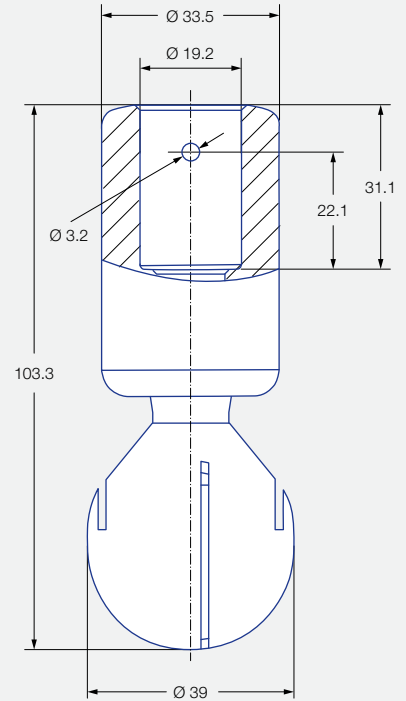

Dimensions of slip-on connection according to ASME-BPE (OD tube)

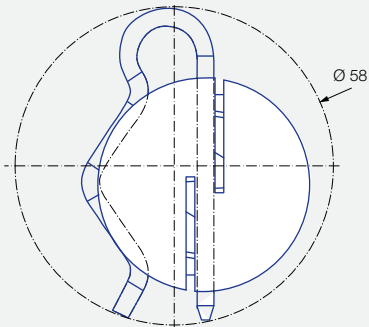



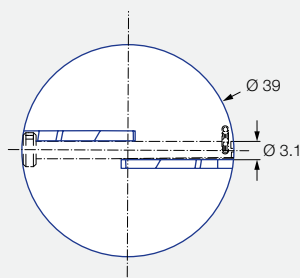

Insertion diameter of slip-on connection stainless steel 1.4404 (316L)



Insertion diameter of slip-on connection 2.4602 (Alloy 22)





Spray angle	Order no.						Narrowest cross-section Ø [mm]	V̇ water [l/min]			V̇ water at 2 bar [m³/h]	Max. tank diameter [m]
	Type	Mat. no.		Connection				p [bar] (p _{max} = 7 bar)				
		1Y	21	1/2 BSPP	3/4 BSPP	3/4" slip-on connection		1.0	2.0	3.0		
60° 	5M3.122	●	●	AH		TF07	2.6	45	63	77	3.8	–
180° 	5M3.133	●	●		AL	TF07	1.2	47	67	82	4.0	2.6
180° 	5M3.134	●	●		AL	TF07	1.3	47	67	82	4.0	2.6
360° 	5M3.999	●	●		AL	TF07	0.4	21	30	37	1.8	1.8
	5M3.089	●	●		AL	TF07	0.7	35	49	60	2.9	2.1
	5M3.139	●	●		AL	TF07	0.8	49	69	85	4.1	2.3
	5M3.209	●	●		AL	TF07	1.5	71	100	122	6.0	2.6

NPT threads, other plug connections and weld-on versions on request.

Information on operation

Compressed air can be used only for a short time for blowing dry. Use above the recommended pressure will have a negative effect on the cleaning result and wear.

Information on slip-on connection

- Cotter pin made of stainless steel 1.4404 (316L) included (05M.330.1Y.00.00). For version made of 2.4602 (Alloy 22), bolt with head incl. cotter pin included (Order no. 05M.332.21.00.00).
- Depending on the adapter diameter, the flow rate may increase due to the leakage between the adapter and rotating cleaning nozzle.

Ordering example with FDA and (EC) 1935/2004 conformity.

All materials are suitable for contact with food.

FDA



Type	+	Material no.	+	Connection	=	Order no.
5M3.122	+	1Y	+	AH	=	5M3.122.1Y.AH

Ordering example with ATEX approval, FDA and (EC) 1935/2004 conformity.

Unit group/Category/Zones:
 ⚠ II 1G Ex h IIB T6...T2 Ga
 ⚠ II 1D Ex h IIIC T85 °C...T250 °C Da

Ex

FDA

Important
 The code for the connection changes for the ATEX version with slip-on connection.
 Ordering example for slip-on connection: 5M3.122.1Y.T2.EX

Type	+	Material no.	+	Connection	+	ATEX	=	Order no.
5M3.122	+	1Y	+	AH	+	EX	=	5M3.122.1Y.AH.EX



Rotating cleaning nozzle MaxiSpinner 2 Series 5M4



Features:

- Hygienic design
- Suitable for high temperatures
- Completely made of stainless steel 1.4404 (316L) or 2.4602 (Alloy 22)



Function video
www.lechler.com/de-en/medialibrary/videos-general-industry
 Or scan the QR code.

Series 5M4

Technical data:



Maximum operating temperature
 200 °C
 95 °C (ATEX)



Maximum ambient temperature
 250 °C
 200 °C (ATEX)



Installation
 Operation in every installation position



Bearing
 Double ball bearing made of stainless steel 1.4404 (316L) or 2.4602 (Alloy 22)



Material
 Stainless steel 1.4404 (316L) or 2.4602 (Alloy 22)



Weight
 1.1–1.5 kg



Surface quality
 $Ra \leq 0.4 \mu m$



Surface quality
 $Ra \leq 0.8 \mu m$



Steam suitability
 Conditionally suitable



Insertion diameter
 69 mm



Recommended filter
 Line strainer with a mesh size of 0.1 mm/170 mesh



Recommended operating pressure
 2 bar



Adapter
 1 1/4 BSPP and 1 1/2 BSPP are compatible with HygienicFit





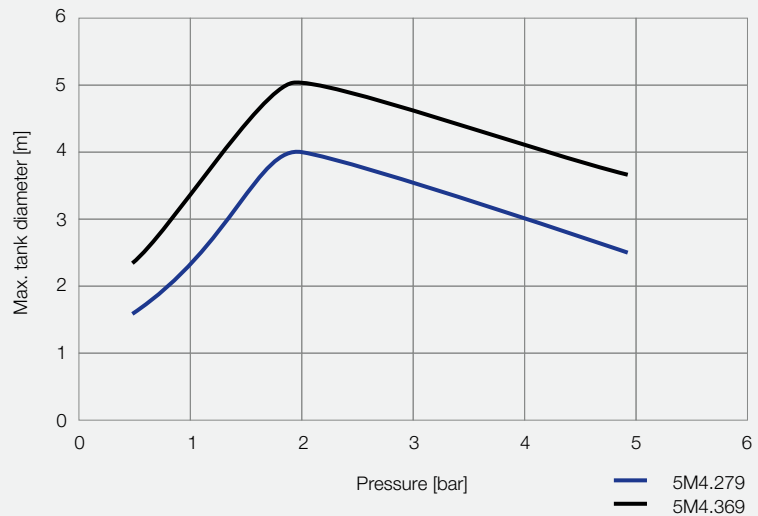

Max. tank diameter
 The specified maximum tank diameter applies to the recommended operating pressure and is indicative only. The type of soiling is also decisive for the cleaning result.

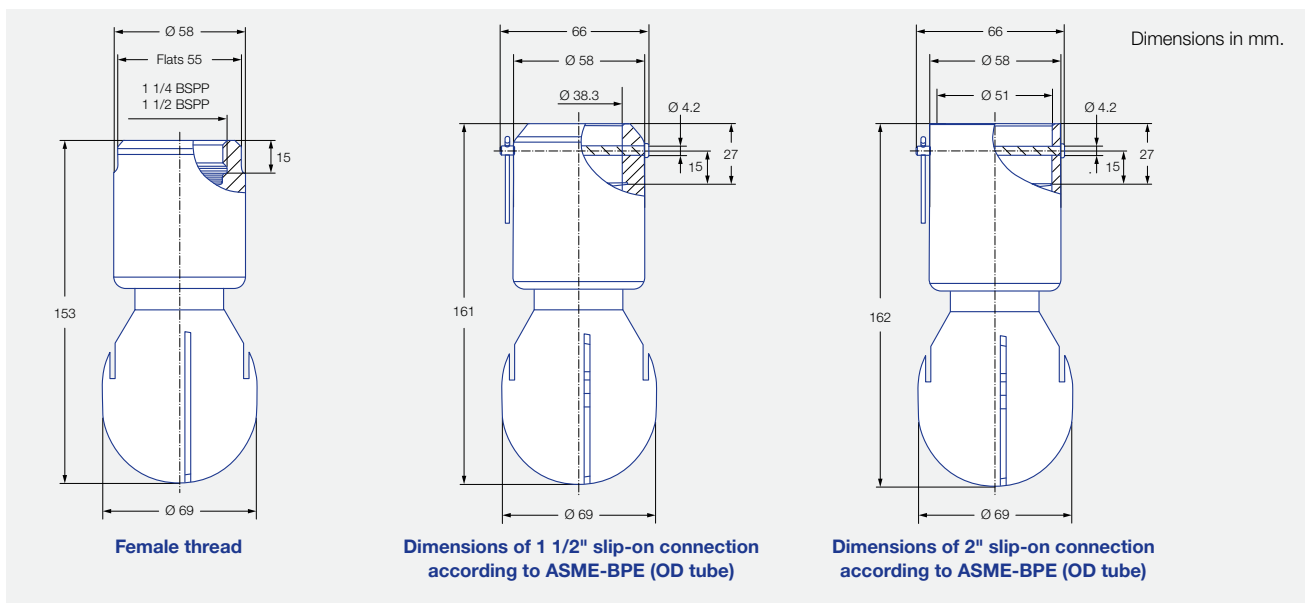

Overview of maximum tank diameter depending on pressure



Spray angle	Type	Order no.						Narrowest cross-section Ø [mm]	V̇ water [l/min]			V̇ water at 2 bar [m³/h]	Max. tank diameter [m]
		Mat. no.		Connection					p [bar] (p _{max} = 7 bar) ¹				
		1Y 1.4404 (316L)	21 2.4602 (Alloy 22)	1 1/4 BSPP	1 1/2 BSPP	1 1/2" slip-on connection	2" slip-on connection		1.0	2.0	3.0		
180° 	5M4.253	●	●	AQ	AS	TF15	TF20	1.8	95	135	165	8.1	4.0
180° 	5M4.254	●	●	AQ	AS	TF15	TF20	2.1	95	135	165	8.1	4.0
270° 	5M4.365	●	●	AQ	AS	TF15	TF20	2.5	177	250	306	15.0	5.0
360° 	5M4.279	●	●	AQ	AS	TF15	TF20	1.7	107	150	184	9.0	4.0
	5M4.329	●	●	AQ	AS	TF15	TF20	2.0	141	200	245	12.0	4.5
	5M4.369	●	●	AQ	AS	TF15	TF20	2.3	177	250	306	15.0	5.0

¹ Please note the maximum operating pressure of 4 for the 2" slip-on connection variant. NPT threads and weld-on version on request.

Information on operation

Compressed air can be used only for a short time for blowing dry. Use above the recommended pressure will have a negative effect on the cleaning result and wear.

Information on slip-on connection

- Bolt with head incl. cotter pin made of 1.4404 (316L) included (Order no. 05M.431.1Y.00.00). For version made of 2.4602 (Alloy 22), bolt with head incl. cotter pin included (05M.431.21.00.00).
- Depending on the adapter diameter, the flow rate may increase due to the leakage between the adapter and rotating cleaning nozzle.

Ordering example with FDA and (EC) 1935/2004 conformity.

All materials are suitable for contact with food.



Type + Material no. + Connection = Order no.
5M4.253 + 1Y + AQ = 5M4.253.1Y.AQ

Ordering example with ATEX approval. FDA and (EC) 1935/2004 conformity.

Unit group/Category/Zones:

- Ex II 1G Ex h IIB T6...T2 Ga
- Ex II 1D Ex h IIIC T85 °C...T250 °C Da

Important

The code for the connection changes for the ATEX version with slip-on connection.

Ordering example for 1 1/2" slip-on connection:
5M4.253.1Y.T5.EX

Ordering example for 2" slip-on connection: 5M4.253.1Y.T6.EX



Type + Material no. + Connection + ATEX = Order no.
5M4.253 + 1Y + AQ + EX = 5M4.253.1Y.AQ.EX

Rotating cleaning nozzle PTFE Whirly Series 573/583



Features:

- Entirely made of PTFE
- 3-A-compliant slip-on connection
- Suitable for corrosive environments
- Suitable for particularly high hygiene requirements (e.g. milk industry)



Function video
www.lechler.com/de-en/medialibrary/videos-general-industry
 Or scan the QR code.

Series 573/583

Technical data:



Maximum operating temperature
95 °C



Maximum ambient temperature
200 °C



Installation
Operation in every installation position



Bearing
Slide bearing made of PTFE



Material
PTFE



Weight
140–300 g



Surface quality
Ra ≤ 0.8 µm



Surface quality
Ra ≤ 0.8 µm



Steam suitability
Not suitable



Insertion diameter
49.0–78.4 mm



Recommended filter
Line strainer with a mesh size of 0.3 mm/50 mesh



Recommended operating pressure
2 bar



Max. tank diameter
The specified maximum tank diameter applies to the recommended operating pressure and is indicative only. The type of soiling is also decisive for the cleaning result.

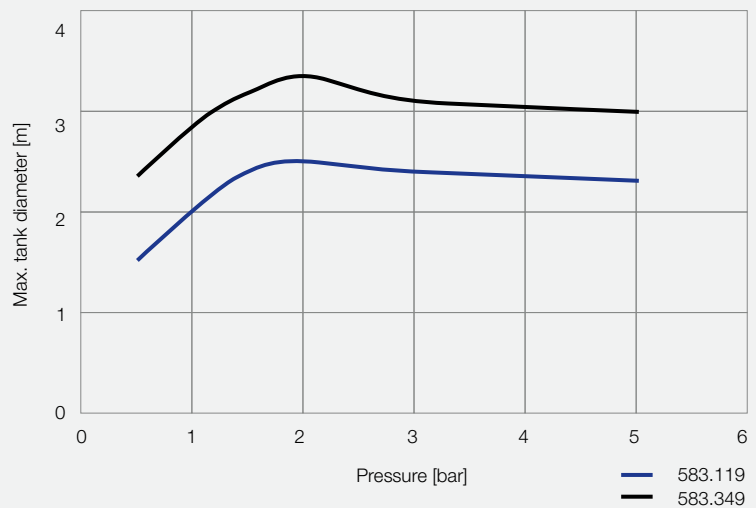

Overview of maximum tank diameter depending on pressure

Dimensions in mm.

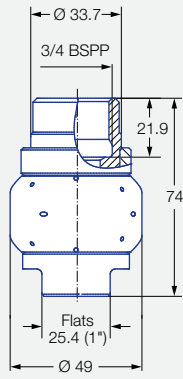

Female thread

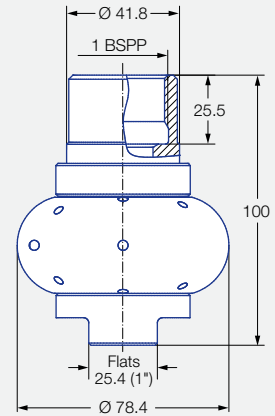

Female thread

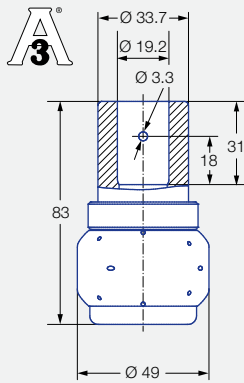

3/4" slip-on connection
(3-A-compliant)
Dimensions of slip-on connection
according to ASME-BPE (OD tube)

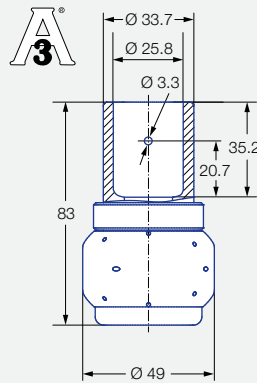

1" slip-on connection pin 1
(3-A-compliant)
Dimensions of slip-on connection
according to ASME-BPE (OD tube)

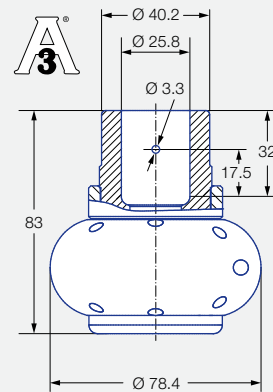

1" slip-on connection pin 2
(3-A-compliant)
Dimensions of slip-on connection
according to ASME-BPE (OD tube)

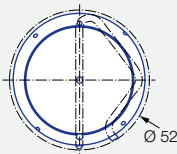

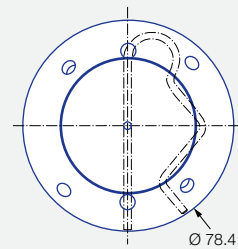

Insertion diameter of
slip-on connection according
to ASME-BPE (OD tube)



Insertion diameter of
slip-on connection according
to ASME-BPE (OD tube)





Spray angle	Order no.					Narrowest cross-section \varnothing [mm]	\dot{V} water [l/min]			\dot{V} water at 2 bar [m ³ /h]	Pin	Max. tank diameter [m]
	Type	Connection					p [bar] (p _{max} = 6 bar)					
		3/4 BSPP	1 BSPP	3/4" slip-on connection	1" slip-on connection		1.0	2.0	3.0			
270° 	583.116.55	AL		TF07		2.4	47	67	82	4.0	1	2.5
	583.346.55				TF10	5.9	159	225	276	13.5	2	3.2
270° 	573.116.55	AL		TF07		2.4	47	67	82	4.0	1	2.5
360° 	583.119.55	AL		TF07	TF10	1.8	41	58	71	3.5	1	2.4
	583.209.55	AL		TF07	TF10	3.5	71	100	122	6.0	1	2.5
	583.269.55	AL		TF07		4.8	103	145	178	8.7	1	2.8
	583.279.55		AN		TF10	3.7	106	150	184	9.0	2	3.0
	583.349.55		AN		TF10	5.6	159	225	276	13.5	2	3.2

NPT threads on request.

Information on operation

Compressed air can be used only for a short time for blowing dry. Use above the recommended pressure will have a negative effect on the cleaning result and wear.

Information on slip-on connection

- Cotter pin made of stainless steel 1.4401 (316) included (Order no. for pin 1: 095.013.17.06.60, pin 2: 095.013.17.06.61).
- Depending on the adapter diameter, the flow rate may increase due to the leakage between the adapter and rotating cleaning nozzle.

Ordering Type + Connection = Order no.
example: 583.116.55 + AL = 583.116.55.AL





CLEANING EFFICIENCY CLASS 3 LIGHT TO MEDIUM SOILING

Type Rotating cleaner, free-spinning

Cleaning effect



Drive By the medium

Typical soiling More viscous substances such as chocolate sauce

Nozzle design Special flat fan geometry with direct impact on the entire tank surface



Rotating cleaning nozzle HygienicWhirly Series 594/595



Features:

- Cleaning with effective flat fan jets
- Effective cleaning even at low pressure
- Suitable for foam delivery



Function video
www.lechler.com/de-en/medialibrary/videos-general-industry
 Or scan the QR code.

Series 594/595

Technical data:



Maximum operating temperature
150 °C



Maximum ambient temperature
150 °C



Installation
Operation in every installation position



Bearing
Slide bearing made of PEEK



Material
Stainless steel 1.4404 (316L), PEEK, version with slip-on connection: O-ring made of EPDM



Weight
90–290 g



Surface quality
Ra ≤ 0.8 µm
OUTSIDE



Surface quality
Ra ≤ 0.8 µm
INSIDE



Steam suitability
Suitable



Insertion diameter
31.5–48.0 mm



Recommended filter
Line strainer with a mesh size of 0.3 mm/50 mesh



Recommended operating pressure
3 bar



Max. tank diameter

The specified maximum tank diameter applies to the recommended operating pressure and is indicative only. The type of soiling is also decisive for the cleaning result.

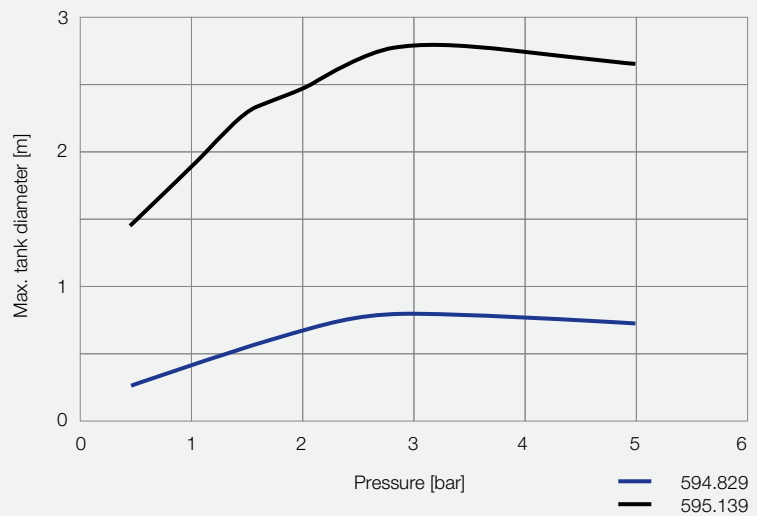

Overview of maximum tank diameter depending on pressure

Dimensions in mm.

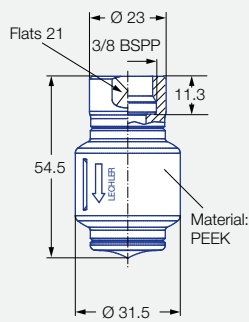

**Standard version
Female thread
59x.xx9.1Y.AF**

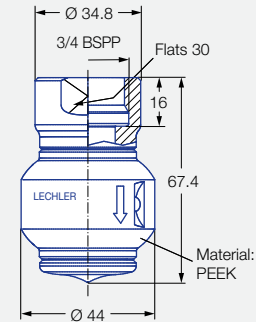

**Standard version
Female thread
595.139.1Y.AL**

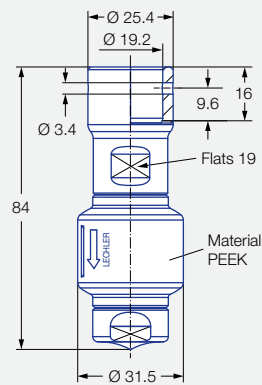

**Dimensions of slip-on
connection according to
ASME-BPE (OD tube)
59x.xx9.1Y.67**

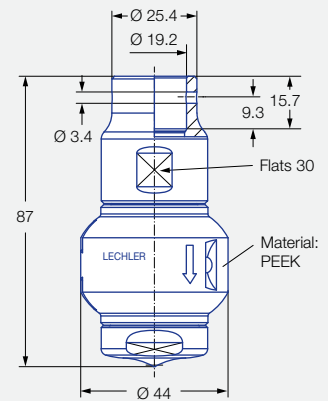

**Dimensions of slip-on
connection according to
ASME-BPE (OD tube)
595.139.1Y.67**

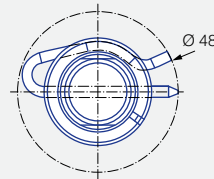

**Insertion diameter
of slip-on connection
59x.xx9.1Y.67**

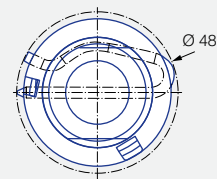

**Insertion diameter
of slip-on connection
595.139.1Y.67**

Spray angle	Order no.				Narrowest cross-section Ø [mm]	V̇ water [l/min]					V̇ water at 3 bar [m³/h]	Max. tank diameter [m]
	Type	Connection				p [bar] (p _{max} = 5 bar)						
		3/8 BSPP	3/4 BSPP	3/4" slip-on connection		0.5	1.0	2.0	3.0	5.0		
360° 	594.829.1Y	AF		67	1.7	6	8	11	14	18	0.8	0.8
	594.879.1Y	AF		67	2.5	8	11	15	18	23	1.1	1.2
	595.009.1Y	AF		67	4.0	16	22	32	39	50	2.3	1.5
	595.049.1Y	AF		67	4.2	20	28	40	49	63	2.9	2.0
	595.139.1Y		AL	67	5.0	34	47	67	82	106	4.9	2.7

NPT threads on request.

Information on operation

Compressed air can be used only for a short time for blowing dry. Use above the recommended pressure will have a negative effect on the cleaning result and wear.

Information on slip-on connection

- Cotter pin made of stainless steel 1.4404 (316L) included (Order no. 095.022.1Y.50.94.E).
- Depending on the adapter diameter, the flow rate may increase due to the leakage between the adapter and rotating cleaning nozzle.

Ordering Type + Connection = Order no.
example: 594.829.1Y + AF = 594.829.1Y.AF

Rotating cleaning nozzle Whirly 2 Series 5W9



Features:

- Popular hygienic design
- Cleaning with effective flat fan jets
- Flexible connection options
- Available with many different flow rates and spray angles



Function video
www.lechler.com/de-en/medialibrary/videos-general-industry
 Or scan the QR code.

Series 5W9

Technical data:

Maximum operating temperature 150 °C 95 °C (ATEX)	Maximum ambient temperature 200 °C 140 °C (ATEX)	Installation Operation in every installation position	Bearing Double ball bearing made of stainless steel
Material Stainless steel 1.4404 (316L), PEEK	Weight 360–500 g	Surface quality Ra ≤ 0.4 µm <small>OUTSIDE</small>	Surface quality Ra ≤ 0.8 µm <small>INSIDE</small>
Steam suitability Not suitable	Insertion diameter 69.5 mm	Recommended filter Line strainer with a mesh size of 0.1 mm/170 mesh	Recommended operating pressure 2 bar
Adapter 3/4 BSPP is compatible with HygienicFit			

Max. tank diameter
 The specified maximum tank diameter applies to the recommended operating pressure and is indicative only. The type of soiling is also decisive for the cleaning result.

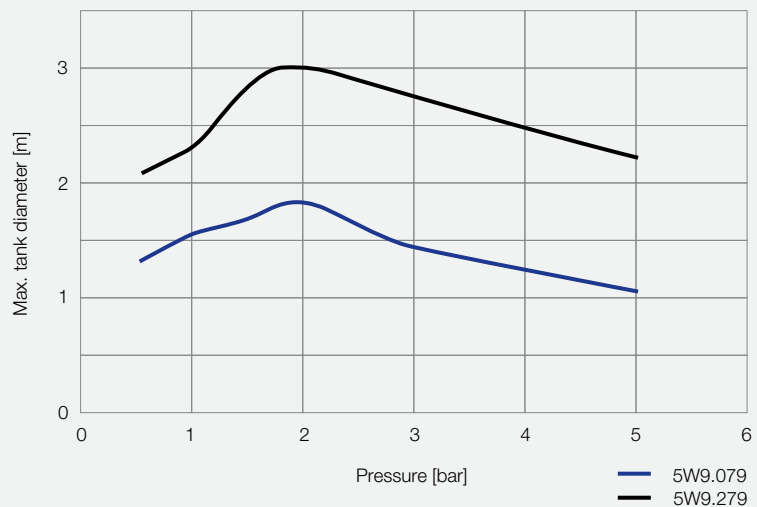

Overview of maximum tank diameter depending on pressure

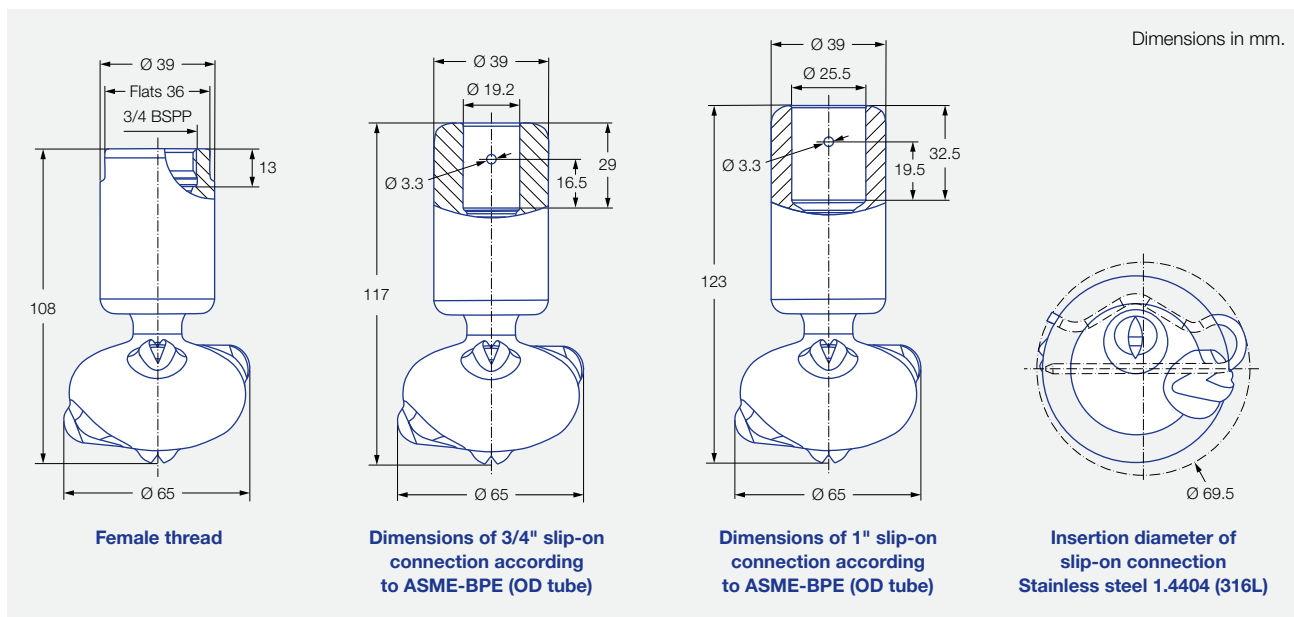

Spray angle	Order no.				Narrowest cross-section \varnothing [mm]	\dot{V} water [l/min]			\dot{V} water at 2 bar [m ³ /h]	Max. tank diameter [m]
	Type	Connection				p [bar] (p _{max} = 6 bar)				
		3/4 BSPP	3/4" slip-on connection	1" slip-on connection		1.0	2.0	3.0		
270° 	5W9.075.1Y	AL	TF07	TF10	2.0	34	48	59	2.9	1.8
	5W9.145.1Y	AL	TF07	TF10	2.8	50	71	87	4.3	2.1
	5W9.195.1Y	AL	TF07	TF10	3.3	69	97	119	5.8	2.6
270° 	5W9.076.1Y	AL	TF07	TF10	2.0	34	48	59	2.9	1.8
	5W9.106.1Y	AL	TF07	TF10	2.5	41	58	71	3.5	2.1
	5W9.196.1Y	AL	TF07	TF10	3.4	69	97	119	5.8	2.6
360° 	5W9.079.1Y	AL	TF07	TF10	1.6	34	48	59	2.9	1.8
	5W9.149.1Y	AL	TF07	TF10	2.4	50	71	87	4.3	2.1
	5W9.199.1Y	AL	TF07	TF10	3.0	69	97	119	5.8	2.6
	5W9.279.1Y	AL	TF07	TF10	3.5	103	145	178	8.7	3.0

NPT threads on request.

Information on operation

Compressed air can be used only for a short time for blowing dry. Use above the recommended pressure will have a negative effect on the cleaning result and wear.

Information on slip-on connection

- Cotter pin made of stainless steel 1.4404 (316L) included (Order no. 095.013.1Y.06.72).
- Depending on the adapter diameter, the flow rate may increase due to the leakage between the adapter and rotating cleaning nozzle.

Ordering example with FDA and (EC) 1935/2004 conformity.

All materials are suitable for contact with food.

Type	+ Connection	= Order no.
5W9.075.1Y	+ AL	= 5W9.075.1Y.AL

Ordering example with ATEX approval. FDA and (EC) 1935/2004 conformity.

Unit group/Category/Zones:
 Ex II 1G Ex h IIB T6...T3 Ga
 Ex II 1D Ex h IIIC T85 °C...T170 °C Da

Important
 The code for the connection changes for the ATEX version with slip-on connection.
 Ordering example for 3/4" slip-on connection: 5W9.075.1Y.T2.EX
 Ordering example for 1" slip-on connection: 5W9.075.1Y.T3.EX

Type	+ Connection	+ ATEX	= Order no.
5W9.075.1Y	+ AL	+ EX	= 5W9.075.1Y.AL.EX

Rotating cleaning nozzle Gyro Series 577



Features:

- Cleaning with powerful nozzle inserts
- Suitable for very large tanks
- Available with many different flow rates
- Clogging-resistant and large clear cross-sections



Function video
www.lechler.com/de-en/medialibrary/videos-general-industry
 Or scan the QR code.

Series 577

Technical data:



Maximum operating temperature
95 °C



Maximum ambient temperature
200 °C



Installation
Vertically downwards



Bearing
Slide bearing made of PTFE



Material
Stainless steel 1.4404 (316L), PTFE



Weight
0.64–1.92 kg



Surface quality
Ra ≤ 0.8 µm
OUTSIDE



Surface quality
Ra ≤ 4.0 µm
INSIDE



Steam suitability
Conditionally suitable



Insertion diameter
110–156 mm



Recommended filter
Line strainer with a mesh size of 0.3 mm/50 mesh



Recommended operating pressure
3 bar





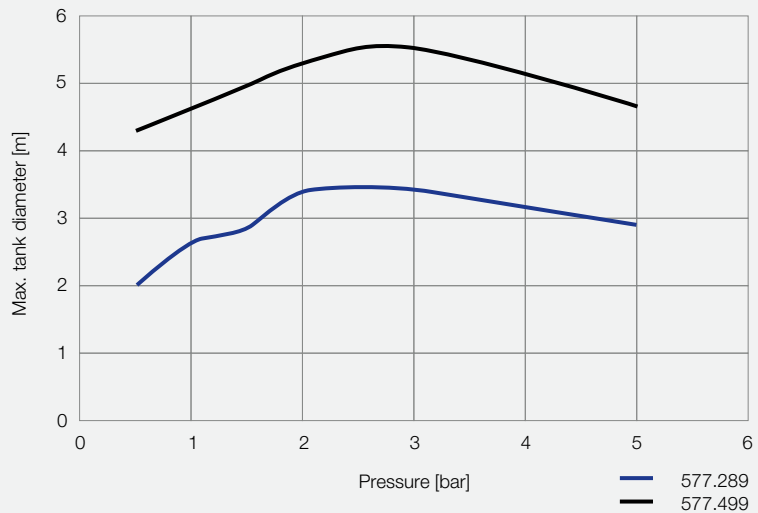

Max. tank diameter
The specified maximum tank diameter applies to the recommended operating pressure and is indicative only. The type of soiling is also decisive for the cleaning result.

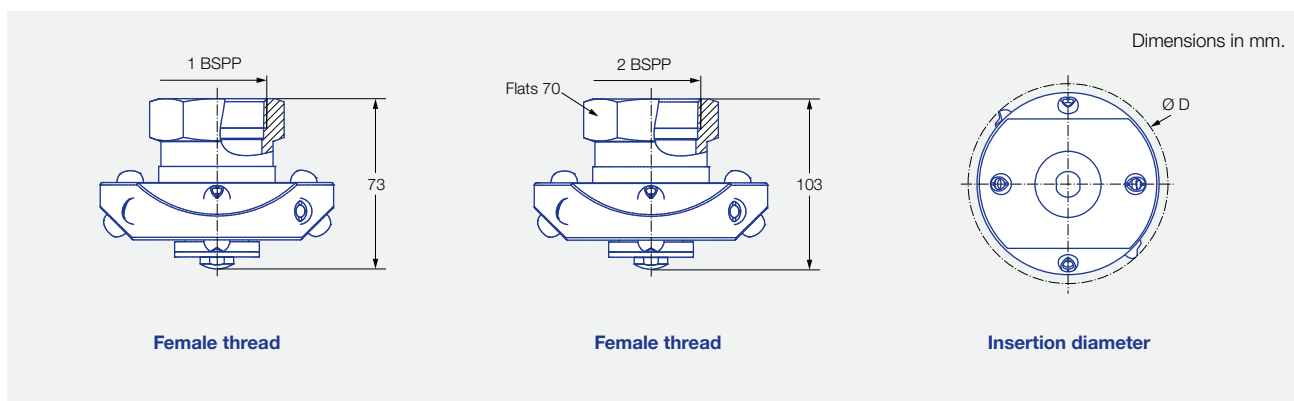

Overview of maximum tank diameter depending on pressure



Spray angle	Order no.		V̇ water [l/min]				V̇ water	Dimensions [mm]	Max. tank diameter [m]	
	Type	Connection		p [bar] (p _{max} = 5 bar)						
		1 BSPP	2 BSPP	1.0	2.0	3.0	5.0	at 3 bar [m³/h]	Ø D	
180° 	577.283.1Y	AN		115	163	200	258	12.0	118	3.4
	577.363.1Y	AN		182	258	316	408	19.0	118	3.9
	577.403.1Y		AW	228	322	394	509	23.6	156	4.2
	577.433.1Y		AW	273	386	473	610	28.4	156	4.6
	577.523.1Y		AW	452	639	783	1,010	39.5	156	5.4
180° 	577.284.1Y	AN		115	163	200	258	12.0	118	3.4
	577.364.1Y	AN		182	258	316	408	19.0	118	3.9
	577.404.1Y		AW	228	322	394	509	23.6	156	4.2
	577.434.1Y		AW	273	386	473	610	28.4	156	4.6
	577.494.1Y		AW	380	538	659	851	39.5	156	5.4
270° 	577.285.1Y	AN		115	163	200	258	12.0	118	3.4
	577.365.1Y	AN		182	258	316	408	19.0	118	3.9
	577.405.1Y		AW	228	322	394	509	23.6	156	4.2
	577.435.1Y		AW	273	386	473	610	28.4	156	4.6
	577.495.1Y		AW	380	538	659	851	39.5	156	5.4
360° 	577.289.1Y	AN		115	163	200	258	12.0	110	3.4
	577.369.1Y	AN		182	258	316	408	19.0	110	3.9
	577.409.1Y		AW	228	322	394	509	23.6	156	4.2
	577.439.1Y		AW	273	386	473	610	28.4	156	4.6
	577.499.1Y		AW	380	538	659	851	39.5	156	5.4

NPT threads on request.

Information on operation

Compressed air can be used only for a short time for blowing dry. Use above the recommended pressure will have a negative effect on the cleaning result and wear.

Ordering Type + Connection = Order no.
example: 577.283.1Y + AN = 577.283.1Y.AN



CLEANING EFFICIENCY CLASS 4 MEDIUM TO HEAVY SOILING

Type	Rotating cleaner, controlled rotation
Cleaning effect	
Drive	By the medium, drive unit with turbine and gear unit
Typical soiling	Medium soiling such as high-viscosity creams
Nozzle design	Special flat fan nozzle inserts with direct impact on the entire tank surface

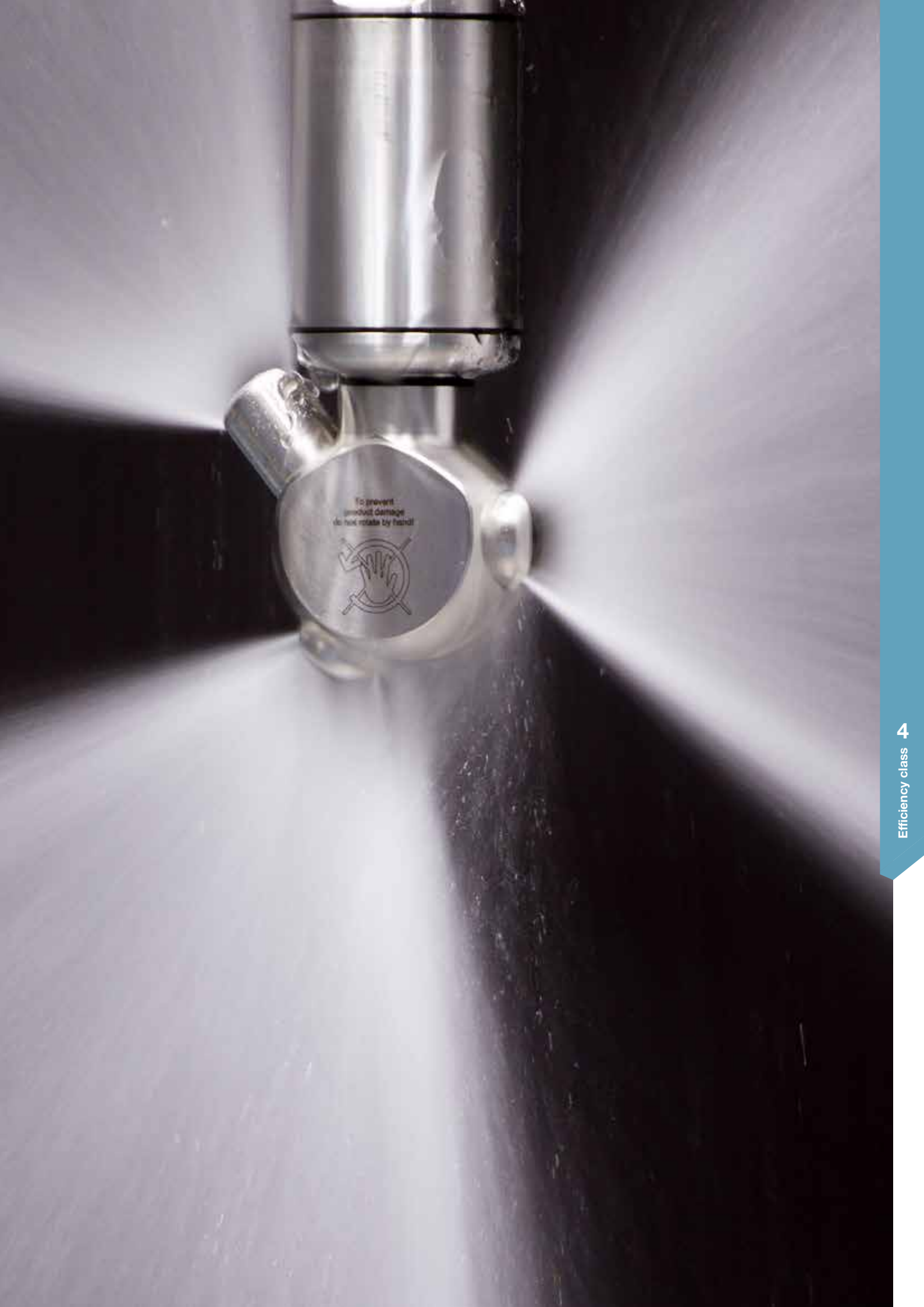

To prevent
product damage
do not rotate by hand!



Rotating cleaning nozzle

XactClean HP 2

Series 5S6/5S7



Features:













- Flat fan nozzle with high impact
- Uniform cleaning
- High efficiency due to controlled rotation
- High operating reliability thanks to robust drive unit



Function video
www.lechler.com/de-en/medialibrary/videos-general-industry
 Or scan the QR code.

Series 5S6/5S7

Technical data:

 Maximum operating temperature 150 °C	 Maximum ambient temperature 150 °C	 Installation Operation in every installation position	 Bearing Double ball bearing
 Material Stainless steel 1.4404 (316L), PEEK, EPDM or FKM	 Weight 650–900 g	 Surface quality Ra ≤ 0.8 µm <small>OUTSIDE</small>	 Surface quality Ra ≤ 1.6 µm <small>INSIDE</small>
 Steam suitability Suitable	 Insertion diameter 50–79 mm	 Recommended filter Line strainer with a mesh size of 0.3 mm/50 mesh	 Recommended operating pressure 3 bar
 Rotation monitoring Sensor-compatible, information: see pages 100–101	 Maintainable	 Adapter 3/8 BSPP, 1/2 BSPP, 3/4 BSPP and 1 BSPP are compatible with HygienicFit	

 **Max. tank diameter**
 The specified maximum tank diameter applies to the recommended operating pressure and is indicative only. The type of soiling is also decisive for the cleaning result.

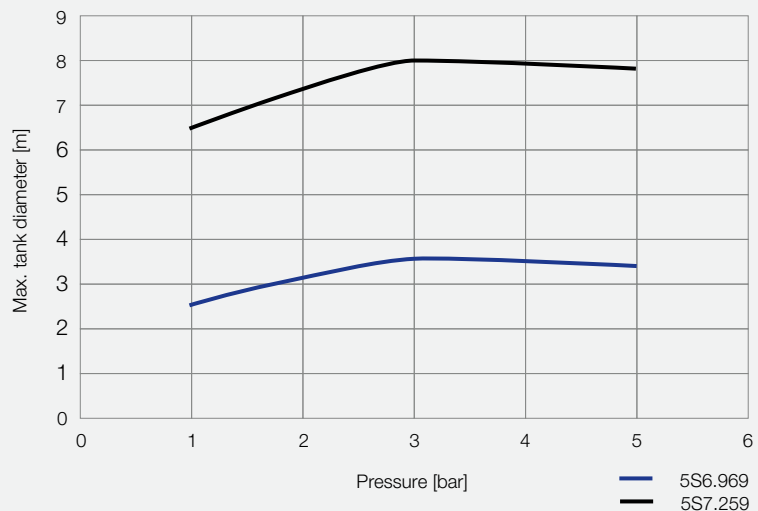

Overview of maximum tank diameter depending on pressure

Dimensions in mm.

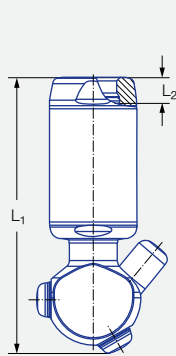

Female thread

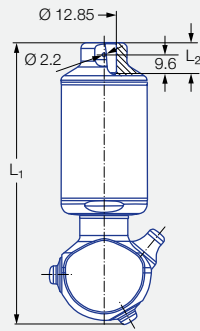

Dimensions of 1/2" slip-on connection according to ASME-BPE (OD tube)

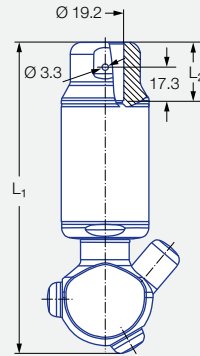

Dimensions of 3/4" slip-on connection according to ASME-BPE (OD tube)

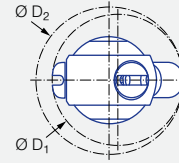

Insertion diameter D_1 and interference circle diameter D_2 of the threaded connection

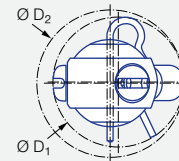





Insertion diameter D_1 and interference circle diameter D_2 of the slip-on connection

EPDM O-rings	FKM O-rings	Connection	Dimensions [mm]			
			L_1	L_2	Insertion diameter D_1	Interference circle diameter D_2
AF	20	3/8 BSPP	141.0	9.0	50.0–66.0	50.0–67.0
AH	21	1/2 BSPP	143.0	13.0	50.0–74.0	50.0–76.0
AL	22	3/4 BSPP	143.0	13.2	50.0–79.0	50.0–81.0
AN	23	1 BSPP	140.0	16.5	51.0–79.0	53.0–80.0
TF05	30	1/2" slip-on connection	150.0	16.0	52.0–66.0	50.0–67.0
TF07	31	3/4" slip-on connection	160.0	30.0	66.0–79.0	50.0–81.0

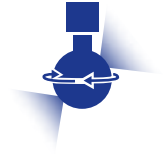
Spray angle	Type	Order no.												Narrowest cross-section \varnothing [mm]	\dot{V} water [l/min]				\dot{V} water at 3 bar [m ³ /h]	Max. tank diameter [m]
		Connection													p [bar] ($p_{max} = 15$ bar)					
		3/8 BSPP		1/2 BSPP		3/4 BSPP		1 BSPP		1/2" slip-on connection		3/4" slip-on connection			2.0	3.0	5.0	10.0		
EPDM	FKM	EPDM	FKM	EPDM	FKM	EPDM	FKM	EPDM	FKM	EPDM	FKM	EPDM	FKM	EPDM	FKM	EPDM	FKM			
180°	5S6.963.1Y	AF	20	AH	21					TF05	30			1.7	25	31	40	57	1.9	3.5
	5S7.043.1Y			AH	21							TF07	31	2.0	41	50	65	92	3.0	4.0
	5S7.113.1Y			AH	21	AL	22					TF07	31	2.0	60	73	94	133	4.4	6.0
	5S7.183.1Y					AL	22					TF07	31	2.0	89	109	141	199	6.5	7.0
	5S7.223.1Y					AL	22					TF07	31	2.0	111	136	175	248	8.2	7.5
	5S7.253.1Y					AL	22	AN	23			TF07	31	2.0	135	165	213	301	9.9	8.0
180°	5S6.964.1Y	AF	20	AH	21					TF05	30			1.7	25	31	40	57	1.9	3.5
	5S7.044.1Y			AH	21							TF07	31	2.0	41	50	65	92	3.0	4.0
	5S7.114.1Y			AH	21	AL	22					TF07	31	2.0	60	73	94	133	4.4	6.0
	5S7.184.1Y					AL	22					TF07	31	2.0	89	109	141	199	6.5	7.0
	5S7.224.1Y					AL	22					TF07	31	2.0	111	136	175	248	8.2	7.5
	5S7.254.1Y					AL	22	AN	23			TF07	31	2.0	135	165	213	301	9.9	8.0





Spray angle	Order no.													Narrowest cross-section Ø [mm]	V̇ water [l/min]				V̇ water at 3 bar [m³/h]	Max. tank diameter [m]			
	Type	Connection													p [bar] (p _{max} = 15 bar)								
		3/8 BSPP		1/2 BSPP		3/4 BSPP		1 BSPP		1/2" slip-on connection		3/4" slip-on connection			2.0	3.0	5.0	10.0					
		EPDM	FKM	EPDM	FKM	EPDM	FKM	EPDM	FKM	EPDM	FKM	EPDM	FKM										
270° 	5S6.965.1Y	AF	20	AH	21								TF05	30			1.7	25	31	40	57	1.9	3.5
	5S7.045.1Y			AH	21										TF07	31	2.0	41	50	65	92	3.0	4.0
	5S7.115.1Y			AH	21	AL	22								TF07	31	2.0	60	73	94	133	4.4	6.0
	5S7.185.1Y					AL	22								TF07	31	2.0	89	109	141	199	6.5	7.0
	5S7.225.1Y					AL	22								TF07	31	2.0	111	136	175	248	8.2	7.5
	5S7.255.1Y					AL	22	AN	23						TF07	31	2.0	135	165	213	301	9.9	8.0
270° 	5S6.966.1Y	AF	20	AH	21								TF05	30			1.7	25	31	40	57	1.9	3.5
	5S7.046.1Y			AH	21										TF07	31	2.0	41	50	65	92	3.0	4.0
	5S7.116.1Y			AH	21	AL	22								TF07	31	2.0	60	73	94	133	4.4	6.0
	5S7.186.1Y					AL	22								TF07	31	2.0	89	109	141	199	6.5	7.0
	5S7.226.1Y					AL	22								TF07	31	2.0	111	136	175	248	8.2	7.5
	5S7.256.1Y					AL	22	AN	23						TF07	31	2.0	135	165	213	301	9.9	8.0
360° 	5S6.969.1Y	AF	20	AH	21								TF05	30			1.5	25	31	40	57	1.9	3.5
	5S7.049.1Y			AH	21										TF07	31	2.0	41	50	65	92	3.0	4.0
	5S7.119.1Y			AH	21	AL	22								TF07	31	2.0	60	73	94	133	4.4	6.0
	5S7.189.1Y					AL	22								TF07	31	2.0	89	109	141	199	6.5	7.0
	5S7.229.1Y					AL	22								TF07	31	2.0	111	136	175	248	8.2	7.5
	5S7.259.1Y					AL	22	AN	23						TF07	31	2.0	135	165	213	301	9.9	8.0

NPT threads on request.

Information on operation

Compressed air can be used only for a short time for blowing dry. Use above the recommended pressure will have a negative effect on the cleaning result and wear.

Information on slip-on connection

- Pin made of stainless steel 316L included (order no. 095.022.1Y.50.60.E (TF07), 095.013.1E.05.59 (TF05)).
- Depending on the adapter diameter, the flow rate may increase due to the leakage between the adapter and rotating cleaning nozzle.

Ordering example with FDA and (EC) 1935/2004 conformity.

All materials are suitable for contact with food.



Type + Connection = Order no.
5S6.965.1Y + AF = 5S6.965.1Y.AF

Ordering example with ATEX approval, FDA and (EC) 1935/2004 conformity.

Unit group/Category/Zones:

- Ex II 1G Ex h IIB T6...T3 Ga
- Ex II 1D Ex h IIIC T85 °C...T190 °C Da

Important

The code for the connection changes for the ATEX version with slip-on connection.
Ordering example for 1/2" slip-on connection: 5S6.963.1Y.T1.EX
Ordering example for 3/4" slip-on connection: 5S7.043.1Y.T2.EX



Type + Connection + ATEX = Order no.
5S6.965.1Y + AF + EX = 5S6.965.1Y.AF.EX



Rotating cleaning nozzle XactClean HP+ Series 5S5

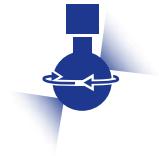

Features:

- High impact and uniform cleaning thanks to specially developed flat fan nozzles
- Effective cleaning of larger tanks through higher flow rates
- High operating reliability due to robust drive unit



Function video
www.lechler.com/de-en/medialibrary/videos-general-industry
 Or scan the QR code.

Series 5S5

Technical data:

Maximum operating temperature 150 °C	Maximum ambient temperature 150 °C	Installation Operation in every installation position	Bearing Double ball bearing
Material Stainless steel 1.4404 (316L), stainless steel 1.4401 (316), PEEK, EPDM	Weight 1.12–1.93 kg	Surface quality Outside Ra ≤ 0.8 µm	Surface quality Inside Ra ≤ 1.6 µm
Steam suitability Suitable	Insertion diameter 81–140 mm	Recommended filter Line strainer with a mesh size of 0.3 mm/50 mesh	Recommended operating pressure 3 bar
Adapter 1 BSPP, 1 1/4 BSPP and 1 1/2 BSPP are compatible with HygienicFit	Rotation monitoring Sensor-compatible, information: see pages 100–101	Maintainable	

Max. tank diameter
 The specified maximum tank diameter applies to the recommended operating pressure and is indicative only. The type of soiling is also decisive for the cleaning result.

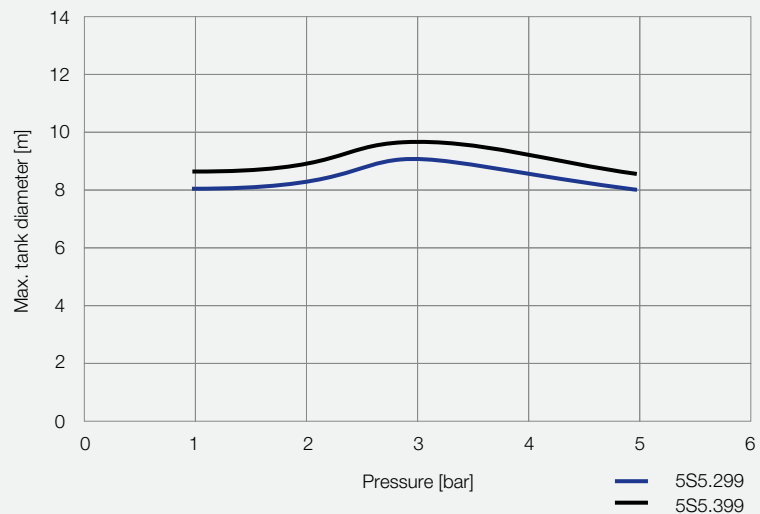

Overview of maximum tank diameter depending on pressure

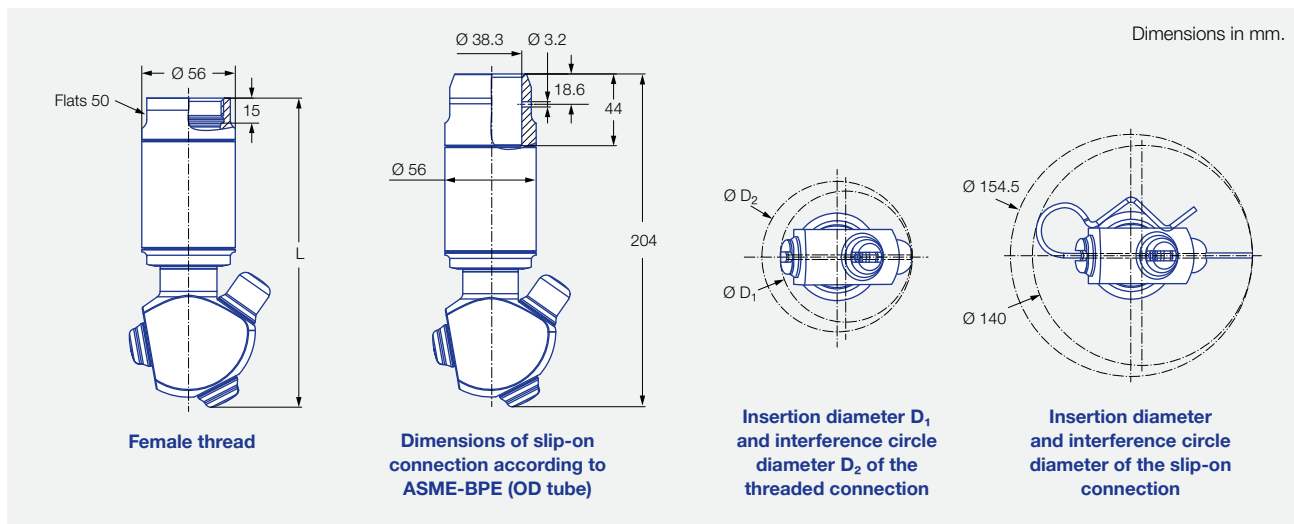

Connection		Dimensions [mm]		
		L	Insertion diameter D_1	Interference circle diameter D_2
AN	1 BSPP	185	81-92	82-98
AQ	1 1/4 BSPP	185	81-92	82-98
AS	1 1/2 BSPP	187	81-92	82-98

Spray angle	Order no.					Narrowest cross-section \varnothing [mm]	\dot{V} water [l/min]			\dot{V} water at 3 bar [m ³ /h]	Max. tank diameter [m]
	Type	Connection					p [bar] ($p_{max} = 10$ bar)				
		1 BSPP	1 1/4 BSPP	1 1/2 BSPP	1 1/2" slip-on connection		2.0	3.0	5.0		
180° 	5S5.293.1Y	AN			TF15	3.0	165	202	261	12.1	9.0
	5S5.323.1Y	AN	AQ		TF15	3.0	200	245	316	14.7	9.2
	5S5.363.1Y		AQ	AS	TF15	3.0	250	306	395	18.4	9.4
180° 	5S5.294.1Y	AN			TF15	3.0	165	202	261	12.1	9.0
	5S5.324.1Y	AN	AQ		TF15	3.0	200	245	316	14.7	9.2
	5S5.364.1Y		AQ	AS	TF15	3.0	250	306	395	18.4	9.4
270° 	5S5.295.1Y	AN			TF15	3.0	165	202	261	12.1	9.0
	5S5.325.1Y	AN	AQ		TF15	3.0	200	245	316	14.7	9.2
	5S5.365.1Y		AQ	AS	TF15	3.0	250	306	395	18.4	9.4
270° 	5S5.296.1Y	AN			TF15	3.0	165	202	261	12.1	9.0
	5S5.326.1Y	AN	AQ		TF15	3.0	200	245	316	14.7	9.2
	5S5.366.1Y		AQ	AS	TF15	3.0	250	306	395	18.4	9.4
360° 	5S5.299.1Y	AN			TF15	3.0	165	202	261	12.1	9.0
	5S5.329.1Y	AN	AQ		TF15	3.0	200	245	316	14.7	9.2
	5S5.369.1Y		AQ	AS	TF15	3.0	250	306	395	18.4	9.4
	5S5.399.1Y		AQ	AS	TF15	3.0	300	367	474	22.0	9.6

NPT threads on request.

Information on operation

Compressed air can be used only for a short time for blowing dry. Use above the recommended pressure will have a negative effect on the cleaning result and wear.

Information on slip-on connection

- Cotter pin made of stainless steel 1.4404 (316L) included (Order no. 095.013.1Y.06.45).
- Depending on the adapter diameter, the flow rate may increase due to the leakage between the adapter and rotating cleaning nozzle.

Ordering Type + Connection = Order no.
example: 5S5.293.1Y + AN = 5S5.293.1Y.AN



CLEANING EFFICIENCY CLASS 5 PERSISTENT SOILING

Type	High impact tank cleaning machine
Cleaning effect	
Drive	By the medium, drive unit with turbine and gear unit
Typical soiling	Persistent soiling such as make-up
Nozzle design	Solid stream nozzles with controlled rotation about two axes, direct impact on the entire tank surface during a cleaning cycle



CLEANING EFFICIENCY CLASS 5 HIGH PRESSURE MOST PERSISTENT SOILING

Type	High pressure tank cleaning machine
Cleaning effect	
Drive	Electric motor
Typical soiling	Most persistent soiling such as dried dough in small tanks
Nozzle design	Solid stream nozzles with controlled rotation about two axes, direct impact on the entire tank surface during a cleaning cycle



High impact tank cleaning machine

MeshClean

Series 5T2/5T3



Features:

- High efficiency thanks to especially powerful solid jet nozzles
- Also suitable for smaller tanks with stubborn soiling
- Active self-cleaning through special nozzle geometry
- Particularly low-maintenance



Function video
www.lechler.com/de-en/medialibrary/videos-general-industry
 Or scan the QR code.

Series 5T2/5T3

Technical data:

Maximum operating temperature 150 °C 150 °C (ATEX)	Maximum ambient temperature 150 °C 150 °C (ATEX)	Installation Operation in every installation position	Bearing Ball bearing
Material Stainless steel 1.4404 (316L), PTFE, PEEK, EPDM or FKM	Weight 1.0 kg	Surface quality Ra ≤ 0.8 µm <small>OUTSIDE</small>	Surface quality Ra ≤ 1.6 µm <small>INSIDE</small>
Steam suitability Suitable	Insertion diameter 68–82 mm	Recommended filter Line strainer with a mesh size of 0.2 mm/80 mesh	Recommended operating pressure 5 bar
Adapter 3/4 BSP is compatible with HygienicFit	Rotation monitoring Sensor-compatible, information: see pages 100–101	Maintainable	

Max. tank diameter
 The specified maximum tank diameter applies to the recommended operating pressure and is indicative only. The type of soiling is also decisive for the cleaning result.

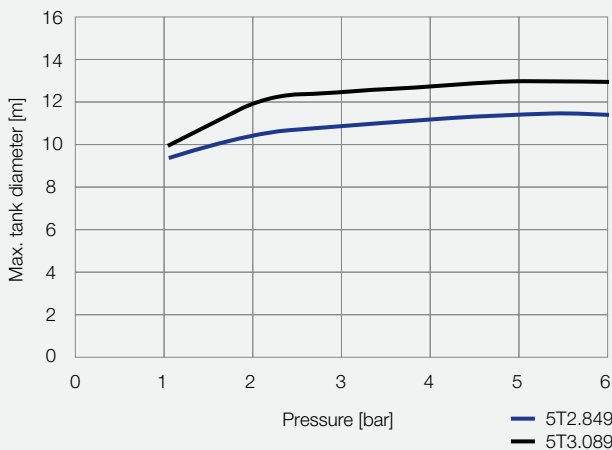

Overview of maximum tank diameter depending on pressure

Duration of cleaning cycle

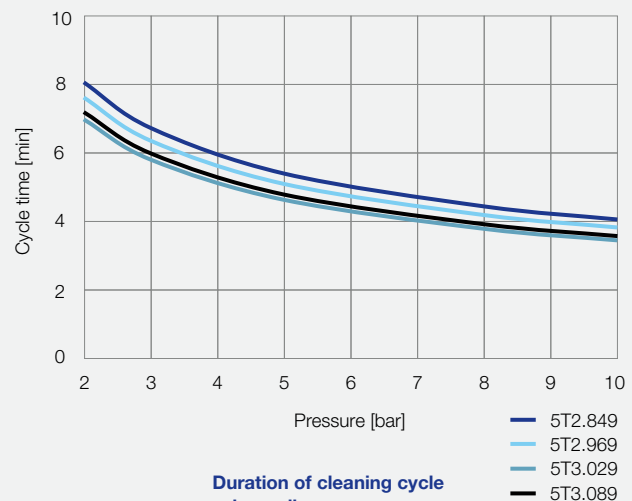

Duration of cleaning cycle depending on pressure

Dimensions in mm.

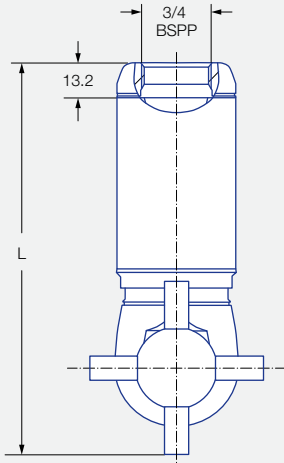

Female thread

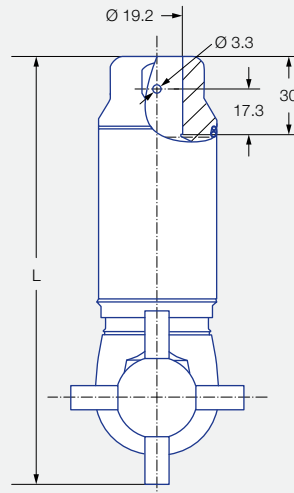

Dimensions of slip-on connection according to ASME-BPE (OD tube)

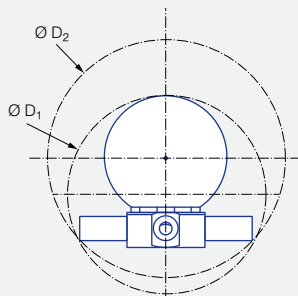

Insertion diameter D_1 and interference circle diameter D_2 of the threaded connection

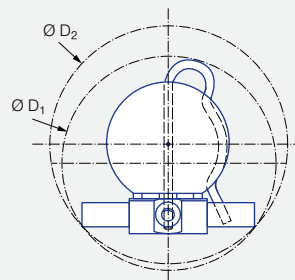

Insertion diameter D_1 and interference circle diameter D_2 of the slip-on connection

Spray angle	Order no.					Narrowest cross-section \varnothing [mm]	Quantity x \varnothing nozzle [mm]	\dot{V} water [l/min]				\dot{V} water at 5 bar [m ³ /h]	Dimensions [mm]						Max. tank diameter [m]	
	Type	Connection		3/4" slip-on connection				p [bar] ($p_{max} = 15$ bar)					Female thread			Slip-on connection				
		3/4 BSPP		EPDM FKM				2.0		3.0		5.0		L		$\varnothing D_1$		$\varnothing D_2$		
		EPDM	FKM	EPDM	FKM															
360°	5T2.849.1Y	AL	22	TF07	31	1.75	4 x 1.75	13	15	20	28	1,2	142	68	82	157	77	82	11.5	
	5T2.969.1Y	AL	22	TF07	31	2.70	4 x 2.70	25	31	40	57	2,4	142	68	82	157	77	82	12.0	
	5T3.029.1Y	AL	22	TF07	31	3.20	4 x 3.20	35	43	55	78	3,3	142	68	82	157	77	82	12.5	
	5T3.089.1Y	AL	22	TF07	31	4.00	4 x 4.00	50	61	79	112	4,7	148	74	91	163	82	91	13.0	

Information on operation

Compressed air can be used only for a short time for blowing dry. Use above the recommended pressure will have a negative effect on the cleaning result and wear.

Ordering example with FDA and (EC) 1935/2004 conformity.

All materials are suitable for contact with food.



Type + Connection = Order no.
5T2.849.1Y + AL = 5T2.849.1Y.AL

Ordering example with ATEX approval, FDA and (EC) 1935/2004 conformity.

Unit group/Category/Zones:

- Ex II 1G Ex h IIB T6...T3 Ga
- Ex II 1D Ex h IIIC T85 °C...T190 °C Da



Important

The code for the connection changes for the ATEX version with slip-on connection.

Ordering example for 3/4" slip-on connection: 5T2.849.1Y.T2.EX



Type + Connection + ATEX = Order no.
5T2.849.1Y + AL + EX = 5T2.849.1Y.AL.EX

High impact tank cleaning machine

IntenseClean Hygienic

Series 5TB



Features:

- Proven in the pharmaceutical, food and beverage industries
- High surface quality



Function video
www.lechler.com/de-en/medialibrary/videos-general-industry
 Or scan the QR code.

Series 5TB

Technical data:

Maximum operating temperature 150 °C 97 °C (ATEX)	Maximum ambient temperature 150 °C 135 °C (ATEX)	Installation Operation in every installation position	Bearing Ball bearing
Material Stainless steel 1.4404 (316L), stainless steel 1.4532 (632), PTFE, PEEK, zirconium oxide, EPDM	Weight 4.0 kg	Surface quality Ra ≤ 0.8 µm <small>OUTSIDE</small>	Surface quality Ra ≤ 0.8 µm <small>INSIDE</small>
Steam suitability Suitable	Insertion diameter 130 mm	Recommended filter Line strainer with a mesh size of 0.2 mm/80 mesh	Recommended operating pressure 5 bar
Rotation monitoring Sensor-compatible, information: see pages 100–101	Maintainable		

Max. tank diameter
 The specified maximum tank diameter applies to the recommended operating pressure and is indicative only. The type of soiling is also decisive for the cleaning result.

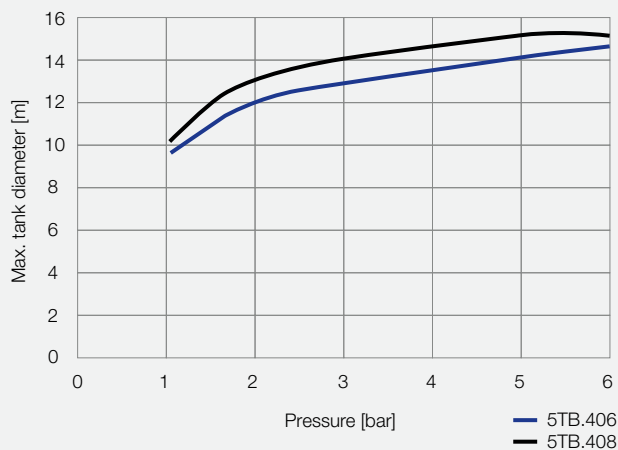

Overview of maximum tank diameter depending on pressure

Duration of cleaning cycle

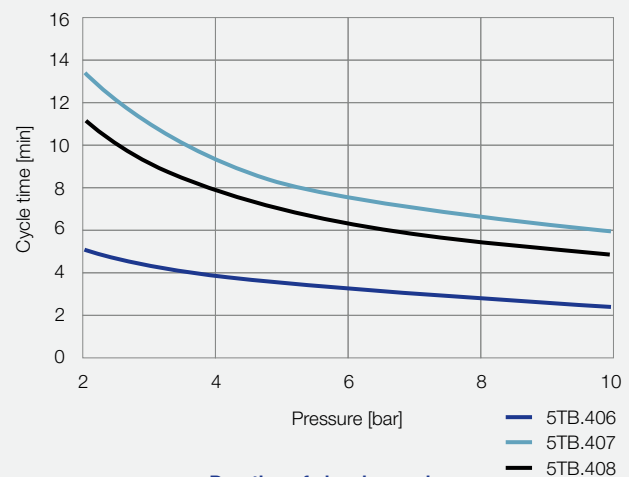

Duration of cleaning cycle depending on pressure

Dimensions in mm.

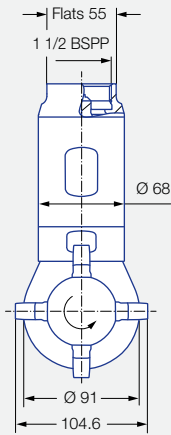

Female thread

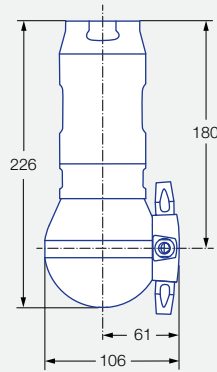

Female thread

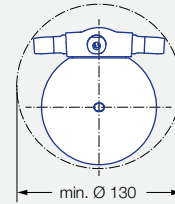

Insertion diameter

Spray angle	Order no.	Narrowest cross-section Ø [mm]	Quantity x Ø nozzle [mm]	V̇ water [l/min]			V̇ water at 5 bar [m³/h]	Max. tank diameter [m]
	Type			p [bar] (p _{max} = 25 bar)				
				2.0	5.0	10.0		
	5TB.406.1Y.AS	6.0	4 x 6.0	107	169	239	10.1	14.0
	5TB.407.1Y.AS	6.0	4 x 7.0	132	209	296	12.5	14.0
	5TB.408.1Y.AS	6.0	4 x 8.0	150	238	336	14.3	15.0

NPT threads on request.

Information on operation

Compressed air can be used only for a short time for blowing dry. Use above the recommended pressure will have a negative effect on the cleaning result and wear.

Ordering example with FDA and (EC) 1935/2004 conformity.



All materials are suitable for contact with food.



Type + Connection = Order no.
5TB.406.1Y. + AS = 5TB.406.1Y.AS

Ordering example with ATEX approval. FDA and (EC) 1935/2004 conformity.



Unit group/Category/Zones:

Ex II 1G Ex h IIB T6...T4 Ga

Ex II 1D Ex h IIIC T85 °C...T135 °C Da



Type + ATEX = Order no.
5TB.406.1Y.AS + EX = 5TB.406.1Y.AS.EX

High impact tank cleaning machine IntenseClean Series 5TM



Features:

- Very robust design
- High efficiency thanks to especially powerful solid jet nozzles
- High efficiency due to gear-controlled rotation
- Proven in the petrochemical industry



Function video
www.lechler.com/de-en/medialibrary/videos-general-industry
 Or scan the QR code.

Series 5TM

Technical data:

Maximum operating temperature 95 °C 95 °C (ATEX)	Maximum ambient temperature 140 °C 120 °C (ATEX)	Installation Operation in every installation position	Bearing Ball bearing
Material Stainless steel 1.4404 (316L), stainless steel 1.4301 (304), stainless steel 1.4310 (302), PTFE, PEEK	Weight 7.40–7.88 kg	Surface quality \sqrt{Ra} OUTSIDE $Ra \leq 0.8 \mu m$	Surface quality \sqrt{Ra} INSIDE $Ra \leq 4.5 \mu m$
Steam suitability Not suitable	Insertion diameter 160–230 mm	Recommended filter Line strainer with a mesh size of 0.2 mm/80 mesh	Recommended operating pressure 5 bar
Rotation monitoring Sensor-compatible, information: see pages 100–101	Maintainable		

Max. tank diameter
 The specified maximum tank diameter applies to the recommended operating pressure and is indicative only. The type of soiling is also decisive for the cleaning result.

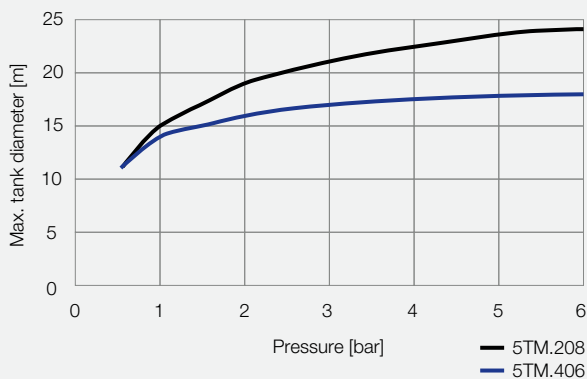

Overview of maximum tank diameter depending on pressure

Duration of cleaning cycle

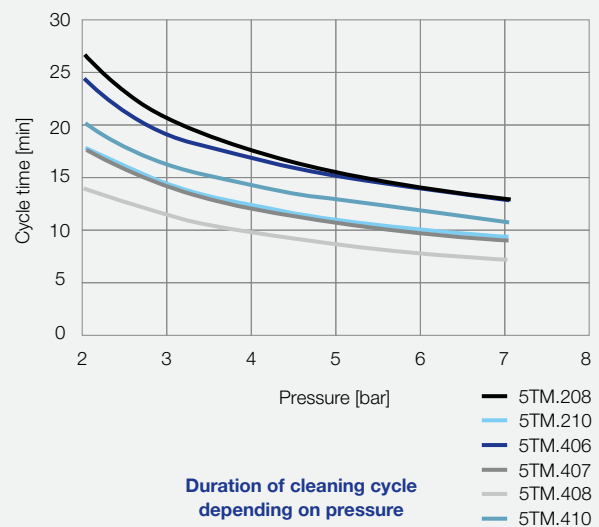

Duration of cleaning cycle depending on pressure

Dimensions in mm.

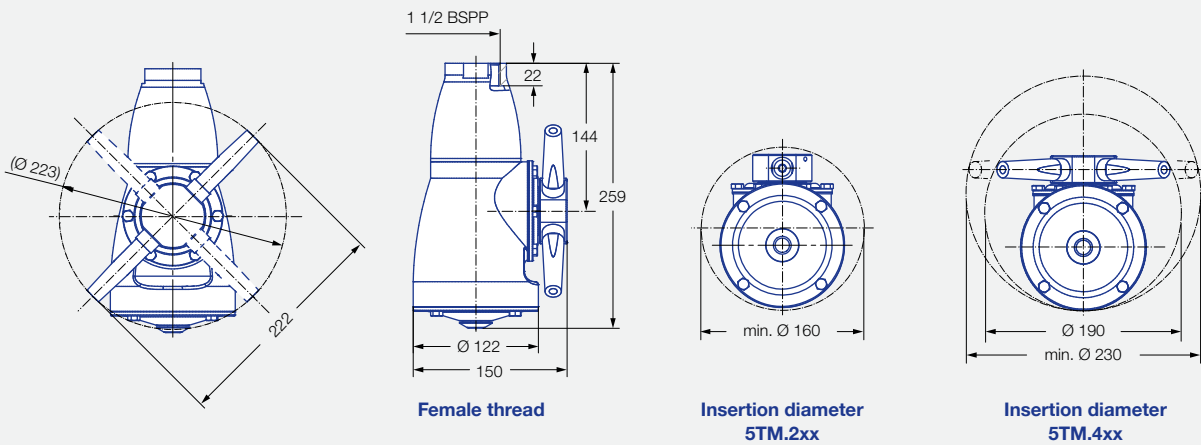

Spray angle	Order no. Type	Narrowest cross-section Ø [mm]	Quantity x Ø nozzle [mm]	V̇ water [l/min]				V̇ water at 5 bar [m³/h]	Max. tank diameter [m]
				p [bar] (p _{max} = 7 bar)					
				2.0	3.0	5.0	7.0		
360° 	5TM.208.1Y.AS	8.0	2 × 8.0	125	153	198	234	11.9	24.0
	5TM.210.1Y.AS	10.0	2 × 10.0	160	196	253	299	15.2	24.0
	5TM.406.1Y.AS	6.0	4 × 6.0	140	171	221	261	13.3	18.0
	5TM.407.1Y.AS	7.0	4 × 7.0	170	208	269	318	16.1	20.0
	5TM.408.1Y.AS	8.0	4 × 8.0	200	245	316	374	19.0	22.0
	5TM.410.1Y.AS	10.0	4 × 10.0	260	318	411	486	24.7	23.0

NPT threads on request.

Information on operation

Compressed air can be used only for a short time for blowing dry. Use above the recommended pressure will have a negative effect on the cleaning result and wear.

Ordering example with FDA and (EC) 1935/2004 conformity.

All materials are suitable for contact with food.



Type + Connection = Order no.
5TM.208.1Y + AS = 5TM.208.1Y.AS

Ordering example with ATEX approval. FDA and (EC) 1935/2004 conformity.



Unit group/Category/Zones:

⊕ II 1G Ex h IIB T6...T3 Ga

⊕ II 1D Ex h IIIC T85 °C...T150 °C Da



Type + ATEX = Order no.
5TM.208.1Y.AS + EX = 5TM.208.1Y.AS.EX

High pressure tank cleaning machine PressureClean Series 5TP



Features:

- Intensive cleaning with little water and high pressure
- Ideal for small tanks with the most persistent soiling
- Driven by an efficient 24 V motor
- "IP 65" certified motor housing
- Scope of delivery:
 - PressureClean
 - 5 m cable with matching plug and open cable end
 - Not included: power supply unit for power supply with 24 VDC/1.1 A



Function video
www.lechler.com/de-en/medialibrary/videos-general-industry
 Or scan the QR code.

Series 5TP

Type	Dimensions [mm]		
	L ₁	L ₂	L ₃
5TP.xx9.1Y.01	566	250	219
5TP.xx9.1Y.02	816	500	469

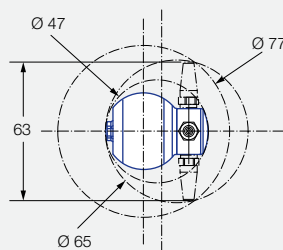

Insertion diameter and interference circle diameter

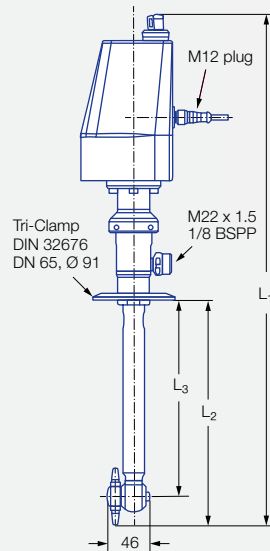

5TP.xx9.1Y.01
5TP.xx9.1Y.02

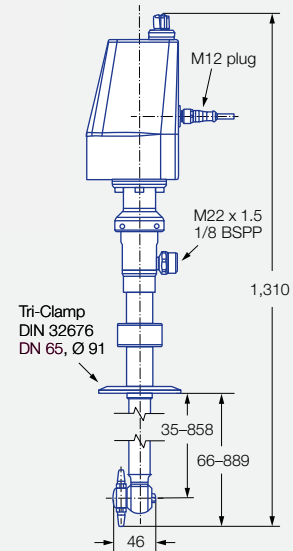

5TP.xx9.1Y.03

Technical data:



Maximum operating temperature
90 °C



Maximum ambient temperature
50 °C



Installation
Operation in every installation position



Bearing
Ball bearing



Material
Process side:
Stainless steel 316L,
PTFE with carbon,
PEEK, Si₃N₄, EPDM



Weight
2.9–5.3 kg



Surface quality
Ra ≤ 1.6 µm
OUTSIDE



Surface quality
Ra ≤ 6.3 µm
INSIDE



Steam suitability
Not suitable



Insertion diameter
65 mm



Recommended filter
Line strainer with a mesh
size of 0.2 mm/170 mesh



Recommended operating pressure
100 bar



Rotation monitoring
Sensor-compatible,
information:
see pages 100–101



Maintainable

Dimensions in mm.



Max. tank diameter

The specified maximum tank diameter applies to the recommended operating pressure and is indicative only. The type of soiling is also decisive for the cleaning result.

Type	Max. tank diameter for most persistent soiling [m]	Max. tank diameter for medium soiling [m]
5TP.469.1Y	1.0	2.5
5TP.589.1Y	1.2	3.0
5TP.659.1Y	1.4	3.5

Adapter for IBC containers:

- Suitable for all types of PressureClean
- Fits into a G 2 female thread
- Scope of delivery:
 - Adapter with Tri-Clamp as interface for PressureClean
 - IBC cover (DN 150, thread S165 x 7) made of HDPE
 - Stainless steel joint clamp with EPDM seal

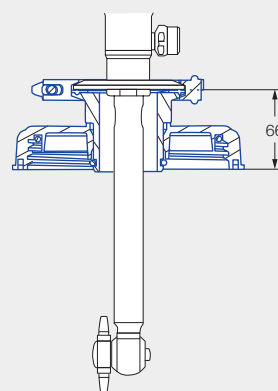
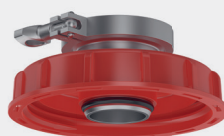

Order no.: 05T.P30.00.00.00

Spray angle	Order no.				V̇ water [l/min]		
	Type	Lance length			p [bar] (p _{max} = 200 bar)		
		250 [mm]	500 [mm]	1,000 [mm] with adjustable flange	50	100	150
360° 	5TP.469.1Y	01	02	03	7	10	12
	5TP.589.1Y	01	02	03	14	20	24
	5TP.659.1Y	01	02	03	21	30	37

Information on operation

- The electric motor may only be switched on when liquid is flowing through the nozzle.

Ordering Type + Lance length = Order no.
 example: 5TP.469.1Y + 01 = 5TP.469.1Y.01



**»» TANK CLEANING
PERFECT ADD**

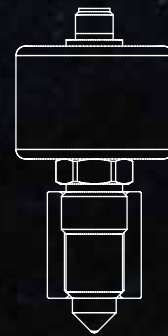

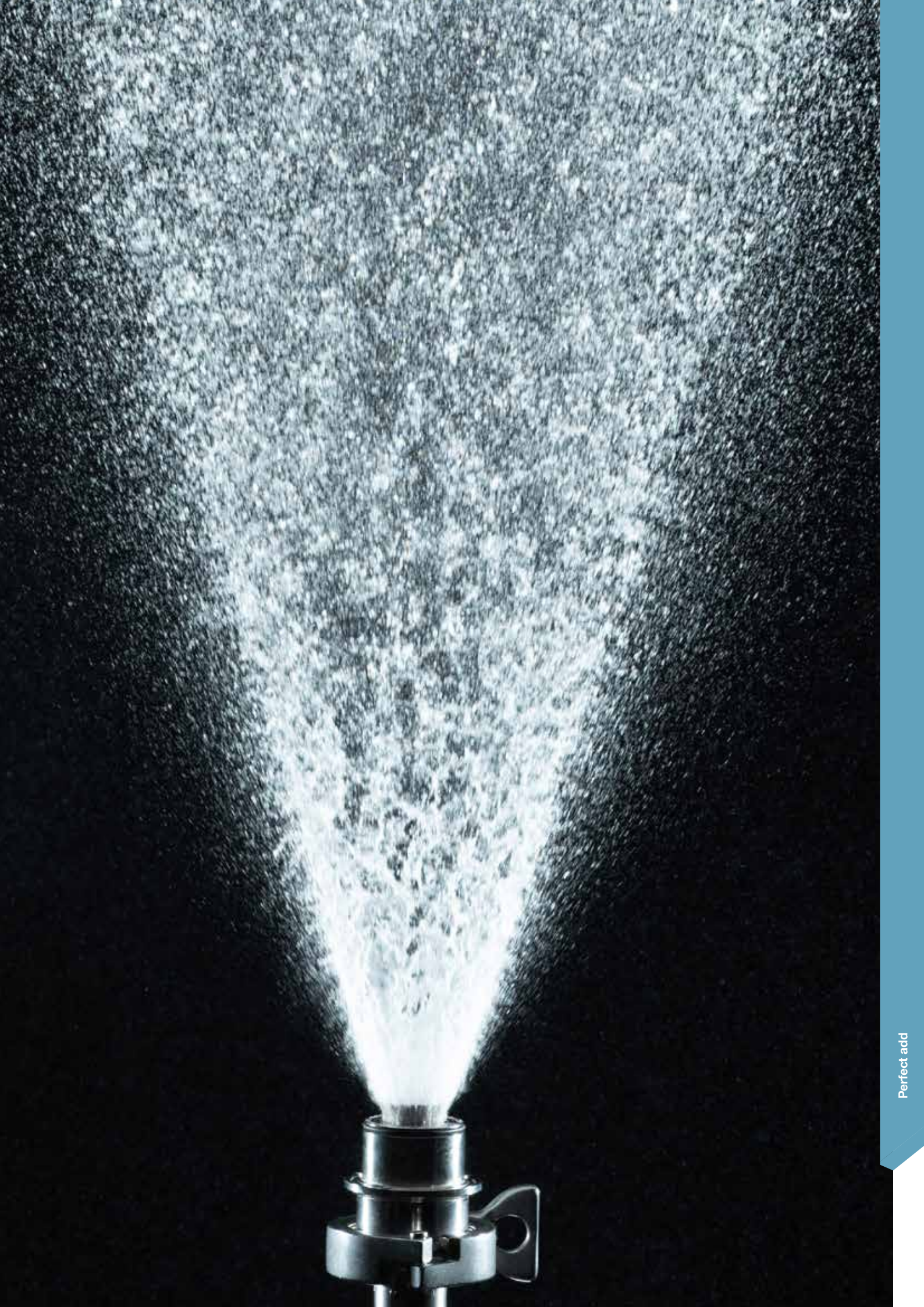

Extendable rotating cleaning nozzle

PopUp Whirly

Series 5P2



Features:

- Rotating cleaning nozzle extends automatically depending on pressure
- Flush wall installation possible
- Good suitability for cleaning pipes
- Particularly suitable for applications in the pharmaceutical, chemical and food industries



Function video
www.lechler.com/de-en/medialibrary/videos-general-industry
 Or scan the QR code.

Series 5P2

Technical data:



Maximum operating temperature
 140 °C
 140 °C (ATEX)



Maximum ambient temperature
 150 °C
 140 °C (ATEX)



Installation
 Operation in every installation position



Bearing
 Slide bearing



Material
 Stainless steel 1.4404 (316L), stainless steel 1.4571 (316Ti), stainless steel 1.4401 (316), FKM



Weight
 500 g



Surface quality
 $Ra \leq 0.8 \mu\text{m}$ on process side, remaining housing
 $Ra \leq 1.6 \mu\text{m}$



Surface quality
 $Ra \leq 1.6 \mu\text{m}$



Steam suitability
 Not suitable



Recommended filter
 Line strainer with mesh size of 0.3 mm/50 mesh



Recommended operating pressure
 2 bar
 Opening pressure approx. 1.0 bar, closing pressure approx. 0.5 bar

Installation example

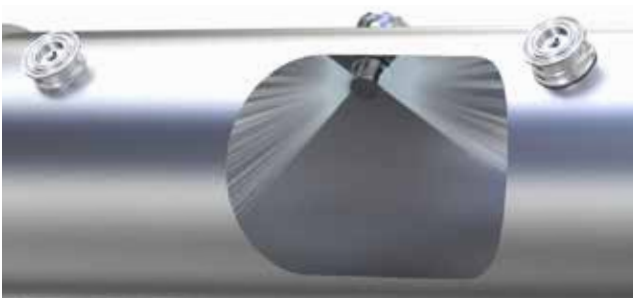

Spray distribution

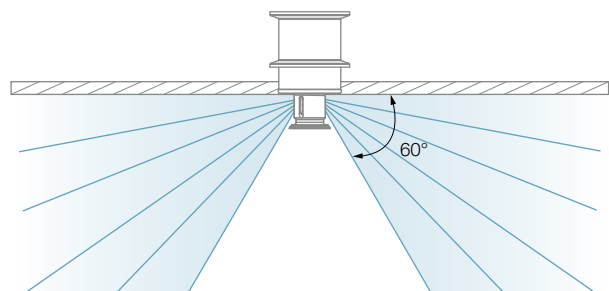

Recommendation for nozzle positioning

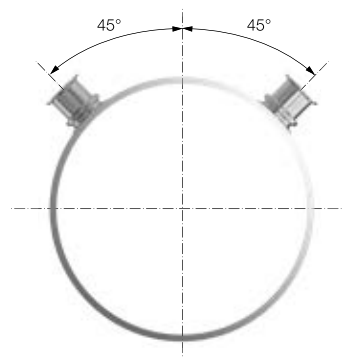
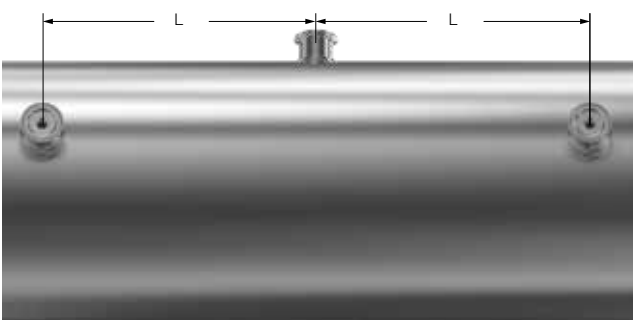

Type	Nozzle spacing L [m]
5P2.873	0.8
5P2.923	1.0

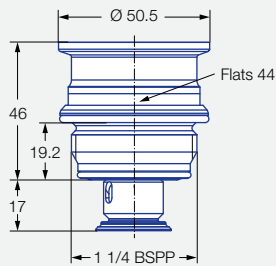

Male thread

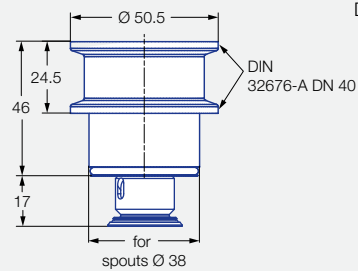

Tri-Clamp connection

Dimensions in mm.

Installation situation

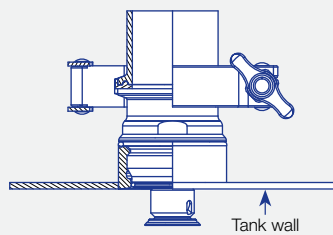

Male thread

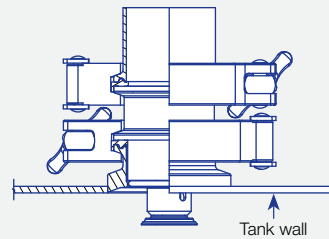

Tri-Clamp connection

Weld-in socket for threaded connection

The thread is hygienically encapsulated with two O-rings (included in the scope of delivery of the PopUp Whirly).

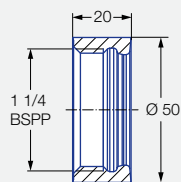

Order no.: 050.020.1Y.AQ.00
Material: Stainless steel 1.4404 (316L)

Weld-in flange for Tri-Clamp connection

A joint clamp in accordance with DIN 32676-A DN50 with a connection diameter of 50.5 mm is required for connection of the nozzle at the weld-in flange. A gasket with a thickness of 2 mm is required if the flange is used in combination with the PopUp Whirly.

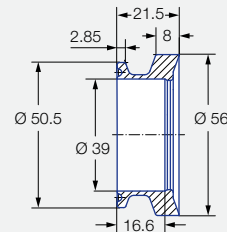

Order no.: 050.020.1Y.01.00
Material: Stainless steel 1.4404 (316L)

Spray angle	Order no.			Narrowest cross-section Ø [mm]	V̇ water [l/min]			V̇ water at 2 bar [m³/h]
	Type	Connection on tank wall			p [bar] (p _{max} = 6 bar)			
		1 1/4 BSPP male	Tri-Clamp		1.0	2.0	3.0	
60°	5P2.873.1Y	AP	00	2.5	11	15	18	0.9
	5P2.923.1Y	AP	00	3.5	14	20	25	1.2

Information on operation

The PopUp Whirly is not suitable for operation with compressed air or another gas. Use above the recommended pressure will have a negative influence on the cleaning result and wear.

Ordering example with FDA and (EC) 1935/2004 conformity.

All materials are suitable for contact with food.



Type + Connection = Order no.
 5P2.873.1Y + AP = 5P2.873.1Y.AP

Ordering example with ATEX approval. FDA and (EC) 1935/2004 conformity.

Unit group/Category/Zones:

Ex II 1G Ex h IIB T6...T3 Ga

Ex II 1D Ex h IIIC T85 °C...T170 °C Da



Type + Connection + ATEX = Order no.
 5P2.873.1Y + AP + EX = 5P2.873.1Y.AP.EX

Extendable rotating cleaning nozzle

PopUp Whirly

Series 5P3



Features:

- Rotating cleaning nozzle extends automatically depending on pressure
- Flush wall installation possible
- Good suitability for cleaning pipes
- Particularly suitable for applications in the pharmaceutical, chemical, food and beverage industries



Function video
www.lechler.com/de-en/medialibrary/videos-general-industry
 Or scan the QR code.

Series 5P3

Technical data:



Maximum operating temperature
 140 °C
 140 °C (ATEX)



Maximum ambient temperature
 150 °C
 140 °C (ATEX)



Installation
 Operation in every installation position



Bearing
 Slide bearing



Material
 Stainless steel 1.4404 (316L), stainless steel 1.4571 (316Ti), stainless steel 1.4401 (316), FKM



Weight
 660 g



Surface quality
 $Ra \leq 0.8 \mu\text{m}$ on process side, remaining housing
 $Ra \leq 1.6 \mu\text{m}$



Surface quality
 $Ra \leq 1.6 \mu\text{m}$



Steam suitability
 Not suitable



Recommended filter
 Line strainer with mesh size of 0.3 mm/50 mesh



Recommended operating pressure
 2 bar
 Opening pressure approx. 0.9 bar, closing pressure approx. 0.5 bar

Installation example

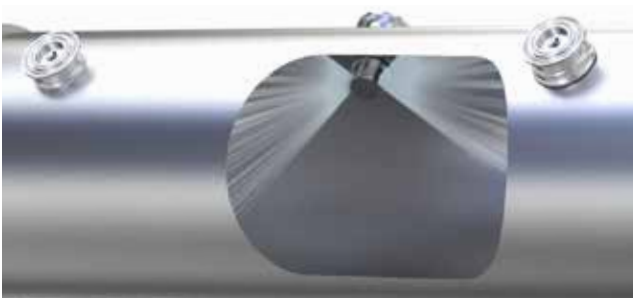

Spray distribution

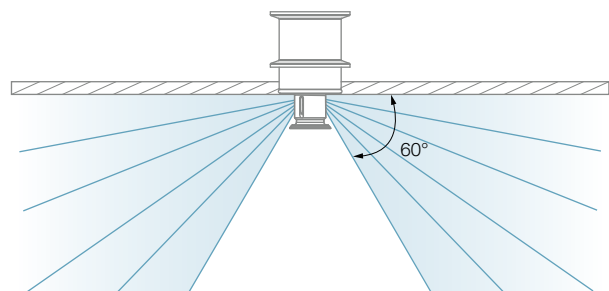

Recommendation for nozzle positioning

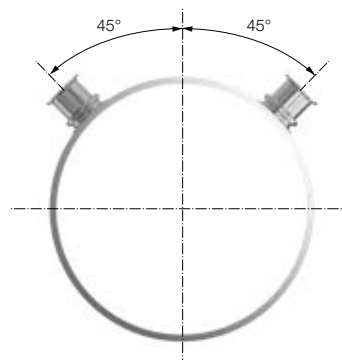
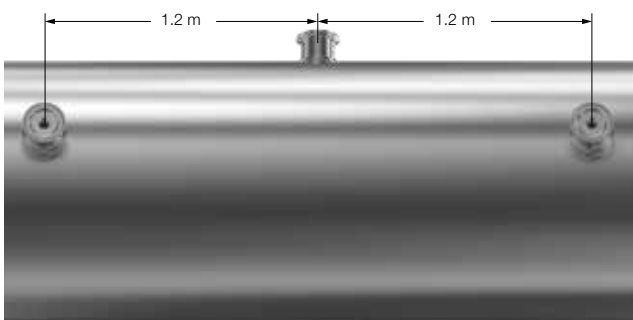

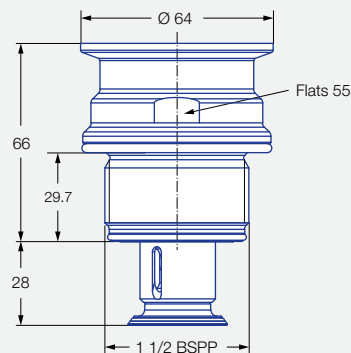

Male thread

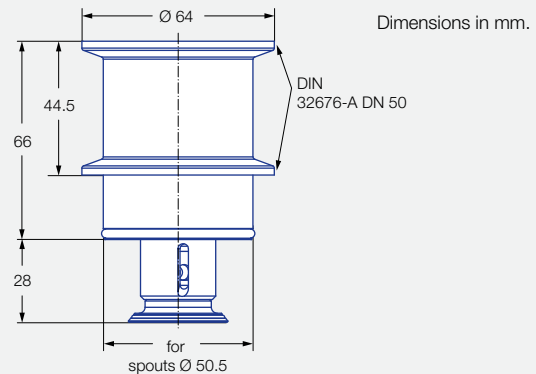

Tri-Clamp connection

Installation situation

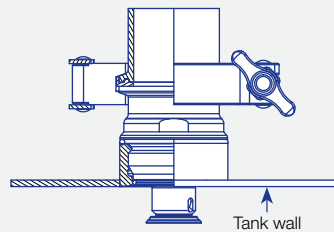

Male thread

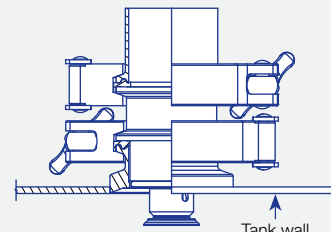

Tri-Clamp connection

Weld-in socket for threaded connection

The thread is hygienically encapsulated with two O-rings (included in the scope of delivery of the PopUp Whirly).

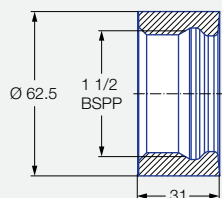

Order no.: 050.020.1Y.AS.00
Material: Stainless steel 1.4404 (316L)

Weld-in flange for Tri-Clamp connection

A joint clamp in accordance with DIN 32676-A DN50 with a connection diameter of 64.0 mm is required for connection of the nozzle at the weld-in flange. A gasket with a thickness of 2 mm is required if the flange is used in combination with the PopUp Whirly.

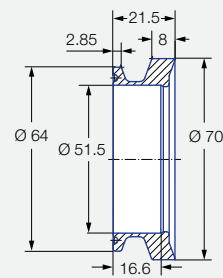

Order no.: 050.020.1Y.01.01
Material: Stainless steel 1.4404 (316L)

Spray angle	Order no.			Narrowest cross-section Ø [mm]	V̇ water [l/min]			V̇ water at 2 bar [m³/h]
	Type	Connection on tank wall			p [bar] (p _{max} = 6 bar)			
		1 1/2 BSPP male	Tri-Clamp		1.0	2.0	3.0	
60° 	5P3.043.1Y	AR	00	3.3	28	40	49	2.4

Information on operation

The PopUp Whirly is not suitable for operation with compressed air or another gas. Use above the recommended pressure will have a negative influence on the cleaning result and wear.

Ordering example with FDA and (EC) 1935/2004 conformity.

All materials are suitable for contact with food.



Type + Connection = Order no.
 5P3.043.1Y + AR = 5P3.043.1Y.AR

Ordering example with ATEX approval. FDA and (EC) 1935/2004 conformity.

Unit group/Category/Zones:
 Ex II 1G Ex h IIB T6...T3 Ga
 Ex II 1D Ex h IIIC T85 °C...T170 °C Da



Type + Connection + ATEX = Order no.
 5P3.043.1Y + AR + EX = 5P3.043.1Y.AR.EX

Extendable cleaning nozzle

PopUp Clean

Series 5P5



Features:

- Cleaning nozzle extends automatically depending on pressure
- Flush wall installation possible
- For cleaning agitators and other spray shadow areas
- Compact, robust design



Function video
www.lechler.com/de-en/medialibrary/videos-general-industry
 Or scan the QR code.

Series 5P5

Technical data:



Maximum operating temperature
 95 °C
 95 °C (ATEX)



Maximum ambient temperature
 150 °C
 140 °C (ATEX)



Installation
 Operation in every installation position



Bearing
 Slide bearing



Material
 Stainless steel 1.4404 (316L), stainless steel 1.4571 (316Ti), FKM or 2.4602 (Alloy 22), 2.4610 (Alloy 4), FKM



Weight
 340 g



Surface quality
 Ra ≤ 0.8 µm on process side, remaining housing
 Ra ≤ 1.6 µm



Surface quality
 Ra ≤ 1.6 µm



Steam suitability
 Not suitable



Recommended filter
 Line strainer with mesh size of 0.3 mm/50 mesh



Recommended operating pressure
 2 bar
 Opening pressure: approx. 0.3 bar, closing pressure: approx. 0.3 bar

Installation example



Spray height

Sprays upwards in vertical installation position.

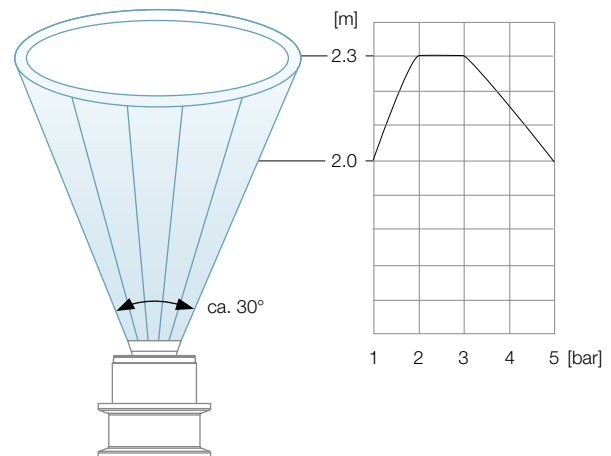

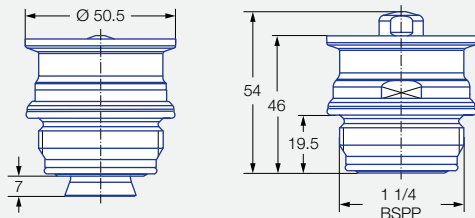

Male threaded connection

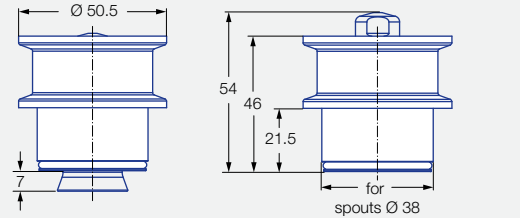

Tri-Clamp connection

Installation situation

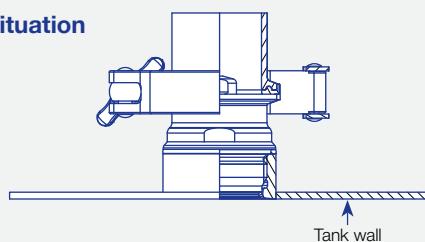

Threaded connection

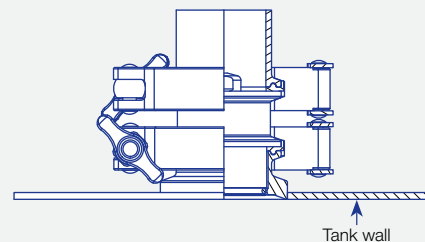

Tri-Clamp connection

Weld-in socket for threaded connection

The thread is hygienically encapsulated with two O-rings (included in the scope of delivery of the PopUp Clean).

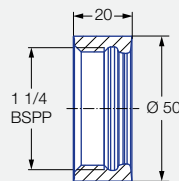

Order no.: 050.020.1Y.AQ.00
Material: Stainless steel 1.4404 (316L)

Weld-in flange for Tri-Clamp connection

A joint clamp in accordance with DIN 32676-A DN50 with a connection diameter of 50.5 mm is required for connection of the nozzle at the weld-in flange. A gasket with a thickness of 2 mm is required if the flange is used in combination with the PopUp Clean.

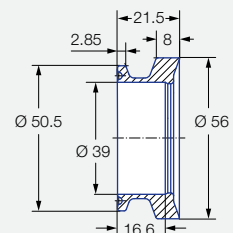

Order no.: 050.020.1Y.01.00
Material: Stainless steel 1.4404 (316L)

Spray angle	Order no.					V̇ water [l/min]				V̇ water	
	Type	Material no.		Connection on tank wall		p [bar] (p _{max} = 5 bar)					
		1Y	21	1 1/4 BSPP male	Tri-Clamp	1.0	2.0	3.0	5.0	at 2 bar [m³/h]	at 5 bar [m³/h]
30° 	5P5.081	●	●	AP	00	35	50	61	79	3.0	4.7

Information on operation

The PopUp Clean is not suitable for operation with compressed air or another gas. Use above the recommended pressure will have a negative influence on the cleaning result and wear.

Ordering example with FDA and (EC) 1935/2004 conformity.

All materials are suitable for contact with food.



Type + Material + Connection = Order no.
 5P5.081 + 1Y + AP = 5P5.081.1Y.AP

Ordering example with ATEX approval. FDA and (EC) 1935/2004 conformity.

Unit group/Category/Zones:

Ex II 1G Ex h IIB T6...T3 Ga

Ex II 1D Ex h IIIC T85 °C...T170 °C Da



Type + Material + Connection + ATEX = Order no.
 5P5.081 + 1Y + AP + EX = 5P5.081.1Y.AP.EX

Extendable rotating cleaning nozzle PopUp Whirly Air Hygienic Series 5P7



Features:

- Position indication by means of sensor (IO-link capable)
- Self-draining in almost any orientation
- Pneumatically extendable, independent of liquid pressure
- Flushable with air
- Installation flush with wall
- No additional installations in the process area



Function video
www.lechler.com/de-en/medialibrary/videos-general-industry
 Or scan the QR code.

Series 5P7

Technical data:



Maximum operating temperature
95 °C



Maximum ambient temperature
65 °C



Installation
Operation in every installation position



Bearing
Slide bearing made of PEEK



Material
Stainless steel 1.4404 (316L), stainless steel 1.4301 (304), PEEK, PTFE, FPM, EPDM



Weight:
4.5 kg



Surface quality
Ra ≤ 1.6 on process side



Surface quality
Ra ≤ 1.6 µm



Steam suitability
Not suitable



Recommended filter
Line strainer with a mesh size of 0.3 mm/50 mesh



Recommended operating pressure
2.5 bar



Maintainable

Installation example



Spray distribution

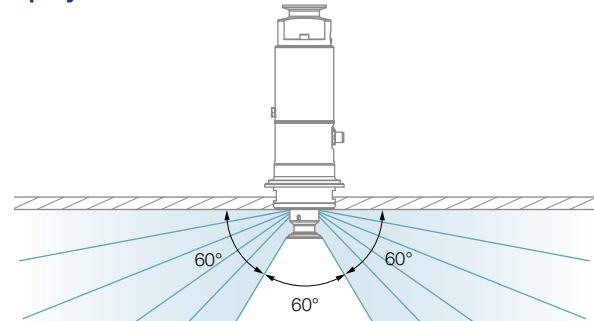

Recommendation for nozzle positioning

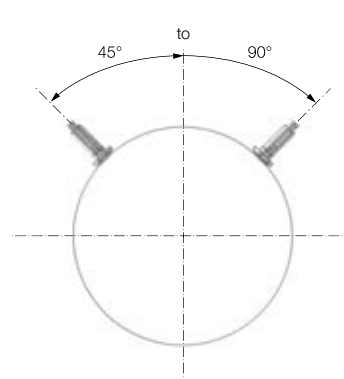
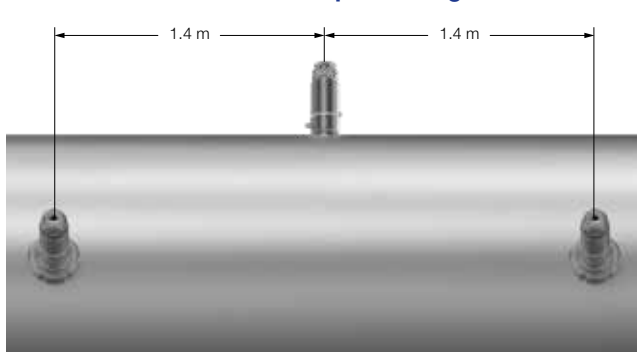

Dimensions in mm
(unless stated otherwise).

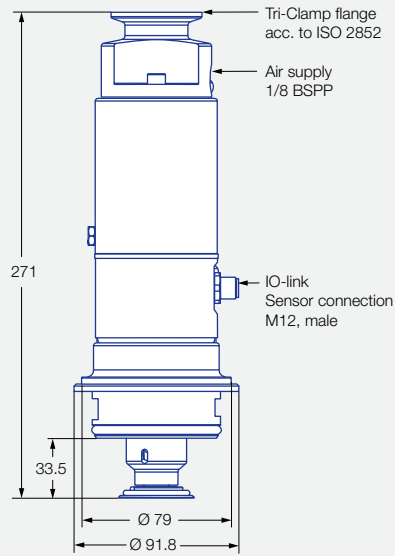

Tri-Clamp flange

Installation situation

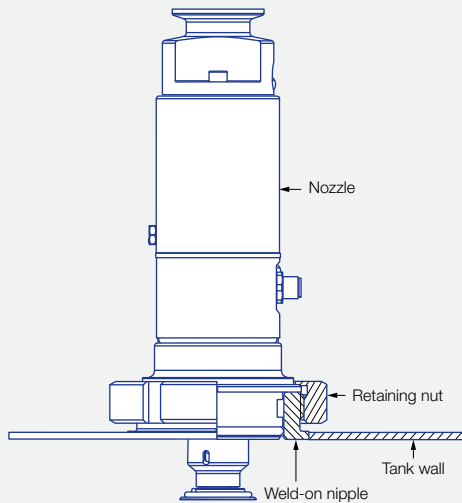

Weld-on nipple for threaded connection

To connect the nozzle on the process side, the weld-in flange 500.605.1Y.00.08 and the retaining nut 095.011.1Y.00.89 (can be ordered from Lechler as an option) are required. The O-ring in the front area of the nozzle in conjunction with the weld-in flange ensures a reliable and hygienic seal.

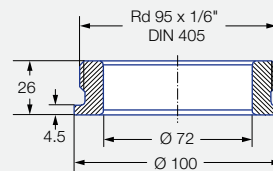

Weld-on nipple

Order no.: 500.605.1Y.00.08

Material: Stainless steel 1.4404 (316L)

Retaining nut

Order no.: 095.011.1Y.00.89

Material: Stainless steel 1.4404 (316L)

Spray angle	Order no.	V̇ water [l/min]					V̇ water at 2.5 bar [m³/h]
	Type	p [bar] (p _{max} = 6 bar)					
		1.0	2.0	2.5	3.0	5.0	
75° 	5P7.074.1Y.00	34.2	48.3	54.0	59.2	76.4	3.2

Information on operation

Use above the recommended pressure will have a negative influence on the cleaning result and wear.

Adapter HygienicFit Series 05C



Features:

- Hygienic threaded connection between equipment and nozzle
- Available for many thread sizes
- Weld-on side suitable for common pipe standards
- O-rings ensure a leak-tight connection
- O-rings fully encapsulate the thread



Function video
www.lechler.com/de-en/medialibrary/videos-general-industry
 Or scan the QR code.

Series 05C

Technical data:



Maximum operating temperature
150 °C



Maximum ambient temperature
150 °C



Installation
Operation in every installation position



Material
1.4404 (316L), EPDM (O-ring)



Weight
70–300 g



Surface quality
Ra ≤ 0.8 µm
OUTSIDE



Surface quality
Ra ≤ 0.8 µm
INSIDE



Steam suitability
Suitable



If you find this icon on our product pages, this means that the nozzle is compatible with the HygienicFit adapter.

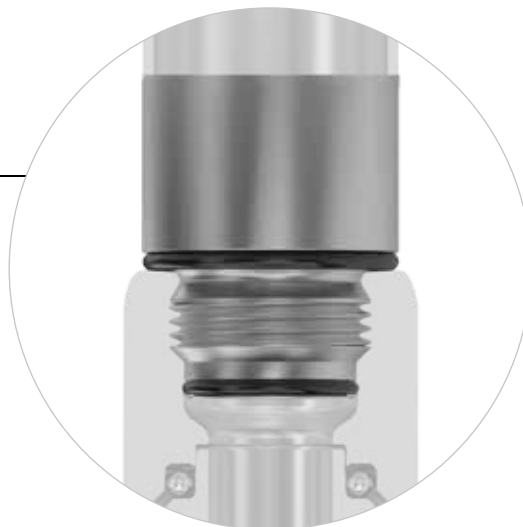

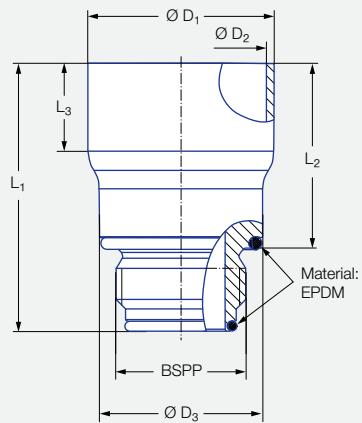

Order no.		Dimensions [mm]						Pipe standard
Type	Connection thread BSPP male	L_1	L_2	L_3	$\varnothing D_1$	$\varnothing D_2$	$\varnothing D_3$	
05C.190.1Y.AE.16	3/8	48.00	35.70	18.00	19.05	15.80	21.50	DIN EN 10357 series D
05C.230.1Y.AE.15	3/8	48.00	35.70	18.00	23.00	20.00	21.50	DIN EN 10357 series A
05C.250.1Y.AE.12	3/8	48.00	35.70	17.00	25.00	22.60	21.50	DIN EN 10357 series D
05C.250.1Y.AG.12	1/2	56.00	39.00	18.00	25.00	22.60	31.00	DIN EN 10357 series D
05C.350.1Y.AK.15	3/4	55.00	37.80	21.00	35.00	32.00	33.50	DIN EN 10357 series A
05C.380.1Y.AK.12	3/4	55.00	37.80	18.00	38.00	35.60	33.50	ISO 2037
05C.381.1Y.AK.15	3/4	55.00	37.80	18.00	38.10	35.10	33.50	DIN EN 10357 series D
05C.381.1Y.AM.16	1	59.00	39.00	23.00	38.10	34.90	40.50	DIN EN 10357 series D
05C.508.1Y.AP.15	1 1/4	57.00	38.00	22.00	50.80	47.80	49.40	DIN EN 10357 series D
05C.635.1Y.AR.16	1 1/2	63.00	44.00	22.00	63.50	60.30	56.00	DIN EN 10357 series D

Spare parts set of O-rings, EPDM

Thread type BSPP	Order no.
3/8	05C.000.E9.AE.00
1/2	05C.000.E9.AG.00
3/4	05C.000.E9.AK.00
1	05C.000.E9.AM.00
1 1/4	05C.000.E9.AP.00
1 1/2	05C.000.E9.AR.00

O-ring set also available in FKM on request.

Rotation monitoring sensor



Features:

- Reliable monitoring of cleaning processes
- Process connection EHEDG-compliant
- Simple operation and PLC connection possible
- Can be individually adapted to each cleaning task
- Operating principle: capacitive



Technical data:



Maximum operating temperature
0–100 °C



Maximum ambient temperature
–10 °C to +60 °C



Installation
Operation in every installation position



Material
Sleeve (1/2 BSPP):
Stainless steel 1.4404 (316L)
Probe tip: PEEK
Housing: 1.4305 (303)



Weight
350 g



Surface quality
Ra ≤ 0.8 µm weld-in flange,
Ra ≤ 1.6 µm PEEK tip



Steam suitability
Max. 125 °C for max.
30 min. at ambient
temperature ≤ 35 °C



Electrical data
Supply voltage:
U_b = 24 V +/-20 %
(18 to 32 VDC)
Power requirement: < 20 mA
Output signal: PNP, 50 mA,
short circuit protected, active



If you find this icon on our product pages, this means that the nozzle is compatible with the rotation monitoring sensor.

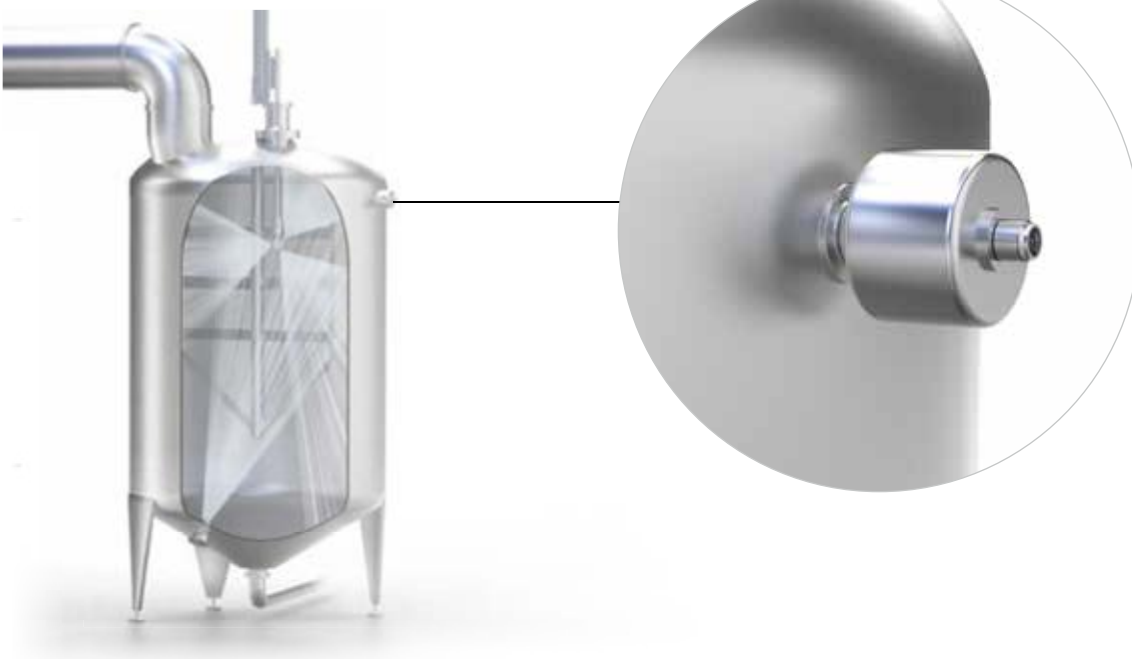

Dimensions in mm.

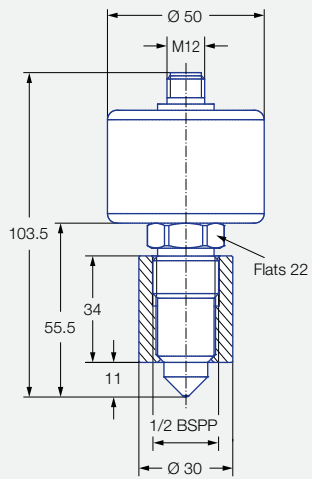

Rotation monitoring sensor with weld-in sleeve



Cable set for commissioning



Power adapter



USB adapter with cable



Programming adapter Y-piece



Weld-in mandrel

Ordering data	Order no.
Rotation monitoring sensor with weld-in sleeve	050.040.00.00.00
Cable set for commissioning	050.040.00.00.01

Software download (free): www.lechler.com/de-en/software/rotatingcontrolsystem

» Cleaning lance StaticLance



Features:

- Optimum nozzle positioning and alignment in the tank
- Individual design possible depending on existing conditions
- Standard material 1.4404 (316L)
- Different material versions optionally available



Static lance

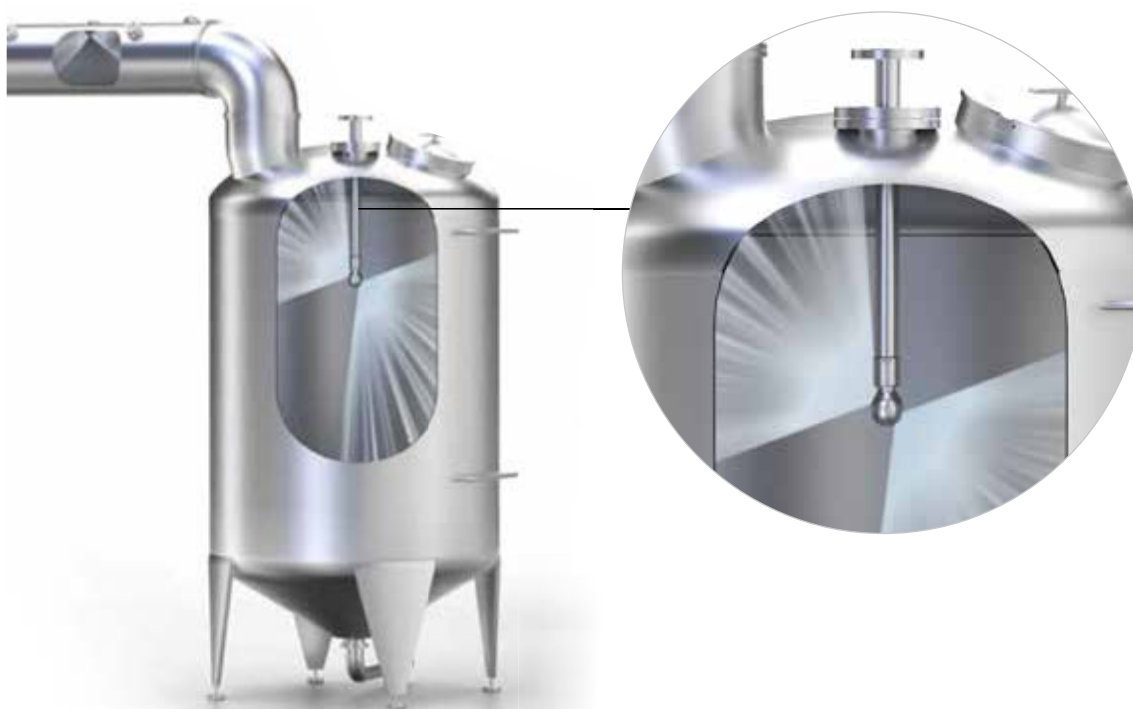

Good to know

If you would like further information on our static lances, please contact us: by phone on +49 7123 962-0 or by email at info@lechler.de.

➤ Cleaning lance FlexLance



Features:

- Stroke length: 1 mm to 2,700 mm
- Material: contact with process 1.4404 (316L), PTFE and EPDM
- Tank cleaning nozzle connection by means of EN 10226 R 3/4 thread
- Driven pneumatic rodless cylinder
- Position monitoring possible (optional)
- Sealed by rod seal on process side
- Process-side flange EN 1092-1 DN 100 PN 16
- Process-side components are food-compliant



Extendable cleaning lance

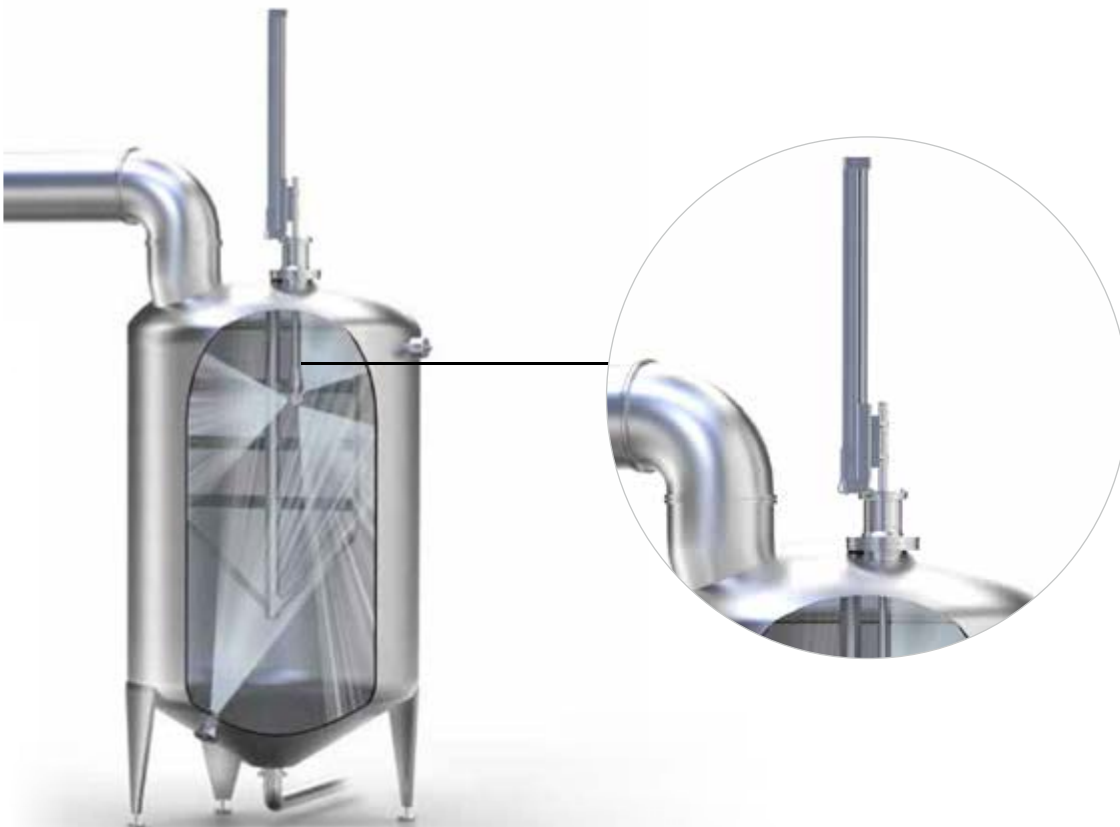

Good to know

In some processes, the tank cleaning nozzle must not remain in the tank during the process. Lechler offers pneumatically extendable cleaning lances so that the tank cleaning nozzle is only in the tank when it is used for cleaning. We will be pleased to discuss your requirements. By phone on +49 7123 962-0 or by email at info@lechler.de.



STAY CLEAN THE LECHLER MAINTENANCE SERVICES



Your systems should operate reliably and efficiently in the long term. That is why we recommend regular maintenance. Lechler offers two options to ensure the shortest possible downtimes of your system and to guarantee prompt recommissioning of your tank cleaning products. We will gladly advise you in person on the best solution for your needs.

Two maintenance options for maximum uptime

ZERO DOWNTIME SERVICE

Maintenance: on-the-spot by the customer.

You independently maintain your cleaning system with the genuine Lechler spare parts on the basis of detailed maintenance instructions and can reduce possible downtimes to zero in an ideal case.

YOUR ADVANTAGES

- Zero downtime possible
- Simply perform maintenance yourself on the basis of detailed instructions
- Use of Lechler genuine parts
- No complex import and export processes
- Cost-efficient maintenance

LECHLER FULL SERVICE

Maintenance: at Lechler by Lechler.

You send in your cleaning equipment and our experts will take care of everything else.

YOUR ADVANTAGES

- Immediate feedback if there are any issues
- Use of Lechler genuine parts
- Lechler Service Points also in your vicinity

Please note that maintenance of ATEX-certified products is possible only within the scope of Lechler Full Service for safety reasons.



If you find this icon on our product pages, this means that maintenance is possible.

Lechler Service

You can find detailed information on the Lechler maintenance concept at www.lechler.com/de-en/service/service-offers Or scan the QR code.





Good to know

Do you have any questions about maintenance? Talk to us. We will gladly advise you. By phone on +49 7123 962-0 or by email at service@lechler.de.



EVERYTHING COVERED CLEAN ALL OVER THE WORLD





- Subsidiary
- Sales office/sales agent

- Headquarters**
- Production**
- Sales**
- Service Points**

Germany
 Lechler GmbH
 Ulmer Strasse 128
 72555 Metzingen, Germany
 Phone +49 7123 962-0
 info@lechler.de

China
 Lechler Nozzle Systems
 (Changzhou) Co., Ltd.
 No.99 Decheng Rd, Jintan
 Changzhou, JS 213200, P.R.C
 Phone +86 400-004-1879
 info@lechler.com.cn

India
 Lechler (India) Pvt. Ltd.
 Plot B-2
 Main Road
 Wagle Industrial Estate Thane
 400604 Maharashtra
 Phone +91 22 40634444
 lechler@lechlerindia.com

USA
 Lechler Inc.
 445 Kautz Road
 St. Charles, IL 60174
 Phone +1 630 3776611
 info@lechlerusa.com

ASEAN
 Lechler Spray Technology
 Sdn. Bhd.
 No. 22, Jalan Astaka 4B/KU2
 Bandar Bukit Raja
 41050 Klang, Selangor
 Malaysia
 Phone +603 3359 1118
 info@lechler.com.my

Belgium
 Lechler S.A./N.V.
 Avenue Newton 4
 1300 Wavre
 Phone +32 10 225022
 info@lechler.be

Finland
 Lechler Oy
 Ansatie 6 a C 3 krs
 01740 Vantaa
 Phone +358 207 856880
 info@lechler.fi

France
 Lechler France SAS
 Parc de la Haute Maison
 6, Allée Képler, Bâtiment C2
 Phone +33 1 49882600
 info@lechler.fr

Great Britain
 Lechler Ltd.
 1 Fell Street, Newhall
 Sheffield, S9 2TP
 Phone +44 114 2492020
 info@lechler.com

Italy
 Lechler Spray Technology S.r.l.
 Via Don Dossetti, 2
 20074 Carpiano (Mi)
 Phone +39 02 98859027
 info@lechleritalia.com

Spain
 Lechler, S.A.
 C / Isla de Hierro, 7 – Oficina 1.3
 28703 San Sebastián de
 los Reyes (Madrid)
 Phone +34 91 6586346
 info@lechler.es

Sweden
 Lechler AB
 Hävertgatan 29
 254 42 Helsingborg
 Phone +46 18 167030
 info@lechler.se

Full range from one source

Efficient cleaning requires controlled generation and distribution of every single drop.

With over 140 years of nozzle expertise and over 45,000 immediately available nozzles, spray systems and accessories, we can realize every spray jet application in a short time. The wide range of proven solid jet, flat fan and solid cone nozzles allows us to offer optimized cleaning solutions for every application.

Global representation

We are at home right at the heart of Europe. In Metzingen we develop highly-efficient cleaning nozzles and test them under practically-based conditions.

We do not just see ourselves as a supplier and manufacturer, however. Because we also support you in optimization of your cleaning processes on-site. Thanks to our international network of production locations, subsidiaries and sales offices/sales representatives, we can always guarantee fast part availability and short distances for service work. Contact us and experience this for yourself.

We look forward to hearing from you.

**ENGINEERING
YOUR SPRAY SOLUTION**



Lechler GmbH · Precision Nozzles · Nozzle Systems

Ulmer Strasse 128 · 72555 Metzingen, Germany · Phone +49 7123 962-0 · info@lechler.de · www.lechler.com

ASEAN: Lechler Spray Technology Sdn. Bhd. · 22, Jln. Astaka 4B/KU2 · Bdr. Bukit Raja · 41050 Klang · Malaysia · Phone +603 3359 1118 · info@lechler.com.my

Belgium: Lechler S.A./N.V. · Avenue Newton 4 · 1300 Wavre · Phone +32 10 225022 · info@lechler.be

China: Lechler Nozzle Systems (Changzhou) Co., Ltd. · No.99 Decheng Rd, Jintan, Changzhou, JS 213200, P.R.C · Phone +86 400-004-1879 · info@lechler.com.cn

Finland: Lechler Oy · Ansatie 6 a C 3 krs · 01740 Vantaa · Phone +358 207 856880 · info@lechler.fi

France: Lechler France SAS · Parc de la Haute Maison · 6, Allée Képler, Bâtiment C2 · 77420 Champs-sur-Marne · Phone +33 1 49882600 · info@lechler.fr

Great Britain: Lechler Ltd. · 1 Fell Street, Newhall · Sheffield, S9 2TP · Phone +44 114 2492020 · info@lechler.com

India: Lechler (India) Pvt. Ltd. · Plot B-2 · Main Road · Wagle Industrial Estate Thane · 400604 Maharashtra · Phone +91 22 40634444 · lechler@lechlerindia.com

Italy: Lechler Spray Technology S.r.l. · Via Don Dossetti, 2 · 20074 Carpiano (Mi) · Phone +39 02 98859027 · info@lechleritalia.com

Spain: Lechler, S.A. · C / Isla de Hierro, 7 – Oficina 1.3 · 28703 San Sebastián de los Reyes (Madrid) · Phone +34 91 6586346 · info@lechler.es

Sweden: Lechler AB · Hävertgatan 29 · 254 42 Helsingborg · Phone +46 18 167030 · info@lechler.se

USA: Lechler Inc. · 445 Kautz Road · St. Charles, IL 60174 · Phone +1 630 3776611 · info@lechlerusa.com



Edition 03/24 · EN · PDF · www.dgm-kommunikation.de
Subject to technical modifications and mistakes.